

Quick Figurator

Custom Cable Assemblies

At www.quickfigurator.com we make it easy for registered users to create cable drawings and specifications using online tools and submit them for quoting and production. Most items are quoted in the same day, so you get the products you need, quickly and conveniently.

Quickest Cable Assembly Design Tool



ENGINEER

PROTOTYPE

TOOLING

PRODUCTION







TABLE OF CONTENTS

Connectors Lugs & Terminals	8-31
Wire & Cable	32-53
Cable Management	54-65
Material Handling.....	66-81
Accessories	82-91
Battery Boxes	92-103
Tools, Testers & Chargers.....	104-127
Power Packs	128-135
Safety & Chemicals.....	136-147
Kits.....	148-156
Retail Program.....	157
Part Number Index	158-164

CONTENTS OF THIS SECTION

CONNECTORS LUGS & TERMINALS

Types of Battery Connectors & Lugs	9
Stud Size Guide	9
Fusion® Lugs	10-11
Quick® Battery Lugs	11-12
MagnaLug™	13-14
MAX® Lugs	14-15
Solder Accessories	15-16
Lead Free OEM Style B-Crimp Terminals.....	16
Marine Terminals	17
Battery Terminals.....	18
Battery Terminal Adapters	19
Fastener Hardware	20
Gardian™ Solderless Heat Shrink Terminals	21
Premium Nylon Double Crimp Terminals.....	22
PVC Terminals.....	23-25
Nylon Terminals.....	25
Premium Nylon Solderless Kit	26
Specialty Terminals and Connectors.....	26
Lead Free Butt Connectors	26-27
Fusion® Butt Connectors	27
Solderless Terminal Kits	28
OEM Non-Insulated Solderless Terminals ..	28-29
Non-Insulated Solderless	30
Weather Pack.....	30



Types of Battery Connectors & Lugs:

Fusion®

- Ideal for heavy duty applications, field repairs, solder and flux preloaded in barrel. Visit www.QuickHowTo.com to learn more about our Fusion® line!



QUICK®

- Crimp, solder and compression die cast lugs designed to perform under the most demanding conditions: heat, vibration, corrosive chemicals.



MagnaLug®

- QuickCable's MagnaLug® line is the heavy duty, high quality, high performance series of copper tube lugs, designed for trucks, buses, agriculture, construction, mining, and other severe duty installations.



MAX Lug

- QuickCable's standard line of copper tube lugs feature seamless construction and quality details you don't always find in OEM quality parts.



Automotive, Marine, Military & Specialty Terminals

- QuickCable's clamp type terminals are available in lead and brass. Lead style clamps are also available with epoxy cote and brass plated fasteners. Some terminals feature long bolt for additional connections. This line provides a variety of configurations.



Stud Size Guide:



1/2"
12.0 mm
0.50"



3/8"
10.5 mm
0.38"



5/16"
8.4 mm
0.31"



1/4"
6.4 mm
0.25"



#10
5.3 mm
0.19"

Fusion® Relative Pull Strength Comparison Chart

- No learning curve - if you can use a torch, you can make a quality connection
- Made of cast copper alloy, tin-plated for added conductivity and to resist corrosion
- Superior reliability for years of dependable service
- Up to 2x stronger than crimp method
- More consistent quality than any other solder method
- Especially good in presence of destructive vibration or corrosive chemicals
- Faster, less confusing and less costly than multi-component solder slug programs
- Fasteners included
- Kits are available
- Truly solderable flags are a Fusion® exclusive, no other solder connector program offers flags or has this capability
- Fusion® barrels are unslotted, so no wire is exposed
- Use with heat-shrink tubing for maximum durability

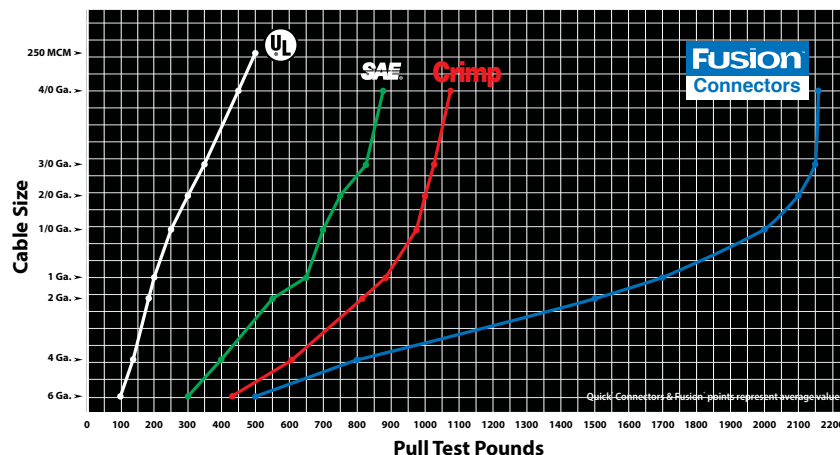
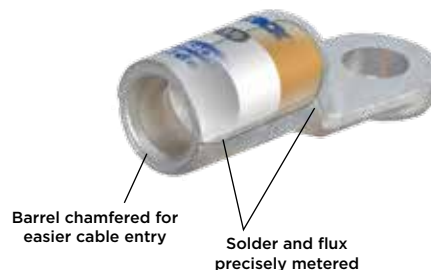

Fusion® Copper Die Cast Terminal Lugs

- Up to 2x stronger than crimp method
- Especially good in presence of destructive vibration or corrosive chemicals
- Faster, less confusing and less costly than multi-component solder slug programs
- Ideal for field repairs, solder & flux preloaded in Barrel
- Visit www.QuickHowTo.com to learn more about our Fusion® line!
- Made in USA

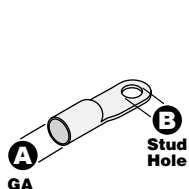

A GA		Straight Clamp		Right Elbow		Left Elbow		Flag Connector		Heavy Wall Lug B Stud Hole	
AWG	mm ²	+	-	+	-	+	-	+	-	3/8" (10 mm)	1/2" (12 mm)
6 & 4	13 & 19	406304P	406304N	-	-	-	-	-	-	486304F	486304H
2 & 1	32 & 40	406301P	406301N	416301P	416301N	426301P	426301N	436301P	436301N	486301F	486301H
1/0	50	406310P	406310N	416310P	416310N	426310P	426310N	436310P	436310N	486310F	486310H
2/0	62	406320P	406320N	416320P	416320N	426320P	426320N	436320P	436320N	486320F	486320H
3/0	81	406330P	406330N	416330P	416330N	426330P	426330N	436330P	436330N	486330F	486330H
4/0	103	406340P	406340N	416340P	416340N	426340P	426340N	436340P	436340N	486340F	486340H

Fusion® Heavy Wall Copper Tube Lugs

- Ideal for field repairs, solder & flux preloaded in Barrel
- Made of heavy wall 100% copper tube for added conductivity and to resist corrosion
- Wider pad for better electrical contact and thicker pad for greater strength and conductivity
- Up to 2x stronger than crimp method
- More consistent quality than any other solder method
- Especially good in presence of destructive vibration or corrosive chemicals
- Visit www.QuickHowTo.com to learn more about our Fusion® line!
- Made in USA



A GA		Starter/Ground Lug				Right Elbow	Left Elbow	Locking, Anti-Rotating Lug		Butt Splice
AWG	mm ²	B Stud Hole				B Stud Hole		End Terminal	Dual Cable	
		1/4" (6 mm)	5/16" (8 mm)	3/8" (10 mm)	1/2" (12 mm)	3/8" (10 mm)	3/8" (10 mm)	B Stud Hole		
								3/8" (10 mm)	3/8" (10 mm)	
2 & 1	32 & 40	141106	141116	141126	141136	–	–	141316	–	–
1/0	50	141107	141117	141127	141137	141207	141217	141317	141307	141410
2/0	62	141108	141118	141128	141138	141208	141218	141318	141308	141420
3/0	81	141109	141119	141129	141139	141209	141219	141319	141309	141430
4/0	103	141110	141120	141130	141140	141210	141220	141320	141310	141440

QUICK® Battery Terminals & Lugs

Precision Die Cast

- Copper alloy, tin plated for added conductivity and corrosion resistance
- Exceeds SAE standards, J163 and J1811
- Precise dimensions to fit battery posts for maximum contact
- For crimp or solder applications
- Fasteners included
- Made in USA



A GA		Straight Clamp			Right Elbow		Left Elbow		Flag		Terminals with Accessory Take-Off	
AWG	mm ²	+	–	U	+	–	+	–	+	–	+	+
		Positive	Negative	Universal	Positive	Negative	Positive	Negative	Positive	Negative	Straight	Flag
8	8	4008P	4008N	4008U	–	–	–	–	–	–	–	–
6	13	4006P	4006N	4006U	4106P	4106N	4206P	4206N	–	–	–	–
4	19	4004P	4004N	4004U	4104P	4104N	4204P	4204N	–	–	–	–
2	32	4002P	4002N	4002U	4102P	4102N	4202P	4202N	4302P	4302N	–	–
1	40	4001P	4001N	4001U	4101P	4101N	4201P	4201N	4301P	4301N	–	–
1/0	50	4010P	4010N	4010U	4110P	4110N	4210P	4210N	4310P	4310N	–	4310PA
2/0	62	4020P	4020N	4020U	4120P	4120N	4220P	4220N	4320P	4320N	4020PA	4320PA
3/0	81	4030P	4030N	4030U	4130P	4130N	4230P	4230N	4330P	4330N	–	4330PA
4/0	103	4040P	4040N	4040U	4140P	4140N	4240P	4240N	4340P	4340N	–	–
250 MCM	126	4060P	4060N	4060U	4160P	4160N	4260P	4260N	4360P	4360N	–	–

Precision Die Cast (Continued)

- For preassembled cable options - see QuickLinks
- Made in USA

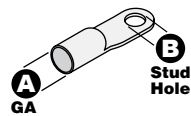

A GA		Heavy Wall Lug			3/8" (10 mm) Crimpable Side Terminal	Stud Terminal Locking		Stud Flag Locking	Add-On Connector	
AWG	mm ²	B Stud Hole				B Stud Hole			Right	Left
		5/16" (8 mm)	3/8" (10 mm)	1/2" (12 mm)	3/8" (10 mm)	1/2" (12 mm)				
8	8	4808E	4808F	4808H	-	-	-	-	-	
6	13	4806E	4806F	4806H	-	4906F	4906H	-	-	
4	19	4804E	4804F	4804H	100653	4904F	4904H	-	-	
2	32	4802E	4802F	4802H	-	4902F	4902H	-	-	
1	40	4801E	4801F	4801H	100655	4901F	4901H	-	-	
1/0	50	4810E	4810F	4810H	-	4910F	4910H	4510F	3710U 3410U	
2/0	62	4820E	4820F	4820H	-	4920F	4920H	4520F	3720P, 3720N 3420P, 3420N	
3/0	81	4830E	4830F	4830H	-	4930F	4930H	4530F	3730U 3430U	
4/0	103	-	4840F	4840H	-	4940F	4940H	-	3740P 3440P	
250 MCM	126	-	4860F	4860H	-	-	-	-	-	



Heavy Wall Lug



Crimpable Side Terminal



Stud Terminal Locking



Stud Flag Locking



Add-On Connector

Compression Battery Terminals

- Ideal for field repairs
- Made of cast copper alloy, tin-plated for added conductivity and corrosion resistance
- All clamps, lugs, compression nuts and fasteners are tin-plated
- Compression nuts color coded to industry standard
- Fasteners included
- Made in USA

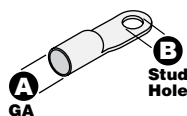

A GA		Straight Clamp			Right Elbow		Left Elbow		Flag Connector			Heavy Wall Lug		Compression Nut
AWG	mm ²	B Stud Hole			B Stud Hole		B Stud Hole		B Stud Hole			3/8" (10 mm)	1/2" (12 mm)	A Gauge
		+	-	U	+	-	+	-	+	-	U			
6	13	5006P	5006N	5006U	-	-	-	-	-	-	-	5806F	5806H	6106
4	19	5004P	5004N	5004U	5104P	5104N	5204P	5204N	5304P	5304N	5304U	5804F	5804H	6104
2 & 1	32 & 40	5002P	5002N	5002U	5102P	5102N	5202P	5202N	5302P	5302N	5302U	5802F	5802H	6102
1/0	50	5010P	5010N	5010U	5110P	5110N	5210P	5210N	5310P	5310N	5310U	5810F	5810H	6110
2/0	62	5020P	5020N	5020U	5120P	5120N	5220P	5220N	5320P	5320N	5320U	5820F	5820H	6120
3/0	81	5030P	5030N	5030U	5130P	5130N	5230P	5230N	5330P	5330N	5330U	5830F	5830H	6130
4/0	103	5040P	5040N	5040U	-	-	-	-	5340P	5340N	5340U	5840F	5840H	6140

MagnaLug®

Heavy Wall Copper Tube Lugs

- Made of 100% copper, tin-plated for added conductivity and to resist corrosion
- Heavy wall copper lugs are 80% thicker than standard lugs
- Wider and thicker pads for greater strength and conductivity
- Excellent for commercial and industrial applications
- Exceeds SAE conductivity standards J163 and J1811
- Conforms to TMC Recommended Practice RO104A, American Trucking Association, for closed eyelet terminals with anti-rotation feature (6200 and 6500 series)
- MagnaLugs® are listed by UL/CUL (UL STD 486A) when applied with QuickCable crimp tools 4255, 4255R, 4255MR and 4255M
- Made in USA



A GA		Starter/Ground Lug				45° Lug		90° Lug		Locking, Anti-Rotating Stackable Lug		
AWG	mm ²	1/4" (6 mm)	5/16" (8 mm)	3/8" (10 mm)	1/2" (12 mm)	B Stud Hole				Single	Single	Dual
						3/8" (10 mm)	1/2" (13 mm)	3/8" (10 mm)	1/2" (12 mm)	B Stud Hole		
		5/16" (8 mm)	3/8" (10 mm)						5/16" (8 mm)	3/8" (10 mm)	3/8" (10 mm)	
8	8	6408D	6408E	6408F	6408H	6408FV	–	6408FL	–	–	–	–
6	13	6406D	6406E	6406F	6406H	6406FV	–	6406FL	–	–	–	–
4	19	6404D	6404E	6404F	6404H	6404FV	6404HV	6404FL	6404HL	6204E	–	–
2 & 1	32 & 40	6401D	6401E	6401F	6401H	6401FV	6401HV	6401FL	6401HL	6201E	6201F	–
1/0	50	6410D	6410E	6410F	6410H	6410FV	6410HV	6410FL	6410HL	6510E	6210F	6510F
2/0	62	6420D	6420E	6420F	6420H	6420FV	6420HV	6420FL	6420HL	–	6220F	6520F
3/0	81	6430D	6430E	6430F	6430H	6430FV	6430HV	6430FL	6430HL	6530E	6230F	6530F
4/0	103	6440D	6440E	6440F	6440H	6440FV	6440HV	6440FL	6440HL	–	6240F	6540F

Heavy Wall Copper Tube Lugs (Continued)



A GA		Right Elbow	Left Elbow	Butt Splice		Retro Fit End Terminal	Retro Fit Dual Cable
AWG	mm ²	B Stud Hole		Regular	Extra Long	B Stud Hole	
		3/8" (10 mm)				3/8" (10 mm)	
6	13	6308F	6318F	–	–	–	–
4	19	6309F	6319F	6804	102455	–	–
2 & 1	32 & 40	6310F	6320F	6801	102456	–	–
1/0	50	6311F	6321F	6810	102457	102560	102660
2/0	62	6312F	6322F	6820	102458	102570	102670
3/0	81	6313F	6323F	6830	102459	102580	102680
4/0	103	6314F	6324F	6840	102460	–	–

* Elbows available with 5/16" hole

Heavy Wall Copper Tube Lugs (Continued)

- For telecom, UPS, utilities and electric generators
- For fire, rescue ambulance and other emergency vehicles
- Ideal for industrial applications, lift trucks and terminals blocks
- Sight hole for cable inspection and “weep hole” for solder dipping
- Made in USA









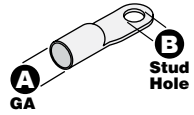

A GA		IND Sight Hole Lug				Starter/Ground Lug				NEMA Two Hole Lug – 1-3/4" Center-to-Center	
AWG	mm ²	B Stud Hole				B Stud Hole				B Stud Hole	
		1/4" (6 mm)	5/16" (8 mm)	3/8" (10 mm)	1/2" (12 mm)	1/4" (6 mm)	5/16" (8 mm)	3/8" (10 mm)	1/2" (12 mm)	3/8" (10 mm)	1/2" (12 mm)
4	19	8904D	8904E	8904F	8904H	8804D	8804E	8804F	8804H	–	–
2 & 1	32 & 40	8901D	8901E	8901F	8901H	8801D	8801E	8801F	8801H	–	–
1/0	50	8910D	8910E	8910F	8910H	8810D	8810E	8810F	8810H	102707	102717
2/0	62	8920D	8920E	8920F	8920H	8820D	8820E	8820F	8820H	102708	102718
3/0	81	8930D	8930E	8930F	8930H	8830D	8830E	8830F	8830H	102709	102719
4/0	103	8940D	8940E	8940F	8940H	8840D	8840E	8840F	8840H	102710	102720

MAX Lugs

Standard Wall Tin Plated Copper Tube Lugs

- Seamless 100% copper tube construction
- Flared barrels for easy installation on cables
- Tin plated for corrosion protection

A GA		Straight Lugs – Tin Plated					45° Lugs – Tin Plated				90° Lugs – Tin Plated				Copper Butt Splice – Tin Plated
AWG	mm ²	B Stud Hole					B Stud Hole				B Stud Hole				
		#10	1/4" (6 mm)	5/16" (8 mm)	3/8" (10 mm)	1/2" (12 mm)	1/4" (6 mm)	5/16" (8 mm)	3/8" (10 mm)	1/2" (12 mm)	1/4" (6 mm)	5/16" (8 mm)	3/8" (10 mm)	1/2" (12 mm)	
8	8	5950C	5950D	5950E	5950F	5950H	5950DV	5950EV	–	–	5950DL	5950EL	5950FL	5950HL	6649
6	13	5951C	5951D	5951E	5951F	5951H	5951DV	5951EV	5951FV	5951HV	5951DL	5951EL	5951FL	5951HL	6650
4	19	5952C	5952D	5952E	5952F	5952H	5952DV	5952EV	5952FV	5952HV	5952DL	5952EL	5952FL	5952HL	6651
2	32	–	5953D	5953E	5953F	5953H	5953DV	5953EV	5953FV	5953HV	5953DL	5953EL	5953FL	5953HL	6652
1	40	–	5954D	5954E	5954F	5954H	5954DV	5954EV	5954FV	5954HV	5954DL	5954EL	5954FL	5954HL	6653
1/0	50	–	5955D	5955E	5955F	5955H	5955DV	5955EV	5955FV	5955HV	5955DL	5955EL	5955FL	5955HL	6654
2/0	62	–	5956D	5956E	5956F	5956H	5956DV	5956EV	5956FV	5956HV	5956DL	5956EL	5956FL	5956HL	6655
3/0	81	–	5957D	5957E	5957F	5957H	5957DV	5957EV	5957FV	5957HV	5957DL	5957EL	5957FL	5957HL	6656
4/0	103	–	5958D	5958E	5958F	5958H	5958DV	5958EV	5958FV	5958HV	5958DL	5958EL	5958FL	5958HL	6657

MAX Lugs

Standard Wall Copper Tube Lugs (Continued) & Butt Splice

- Seamless 100% copper tube construction
- Can be crimped or soldered
- Ideal for general wiring as well as starter or ground connections



A GA		Straight Lugs – Bare Copper					Copper Butt Splice – Tin Plated
		B Stud Hole					
AWG	mm ²	#10	1/4" (6 mm)	5/16" (8 mm)	3/8" (10 mm)	1/2" (12 mm)	
8	8	105015	105016	105017	105018	105019	6649
6	13	105035	105036	105037	105038	105039	6650
4	19	–	105056	105057	105058	105059	6651
2	32	–	105076	105077	105078	105079	6652
1	40	–	105096	105097	105098	105099	6653
1/0	50	–	105116	105117	105118	105119	6654
2/0	62	–	105136	105137	105138	105139	6655
3/0	81	–	105156	105157	105158	105159	6656
4/0	103	–	105176	105177	105178	105179	6657

Brazed Seam Lugs & Butt Splice

- Serrated barrel increases pullout strength
- Ideally suited for solder dipping applications
- 100% copper, tin plated



A GA		Butt Splice	Ring Terminal – Tin Plated						
			B Stud Hole						
AWG	mm ²	#10	1/4" (6 mm)	5/16" (8 mm)	3/8" (10 mm)	7/16" (11 mm)	1/2" (12 mm)	3/4" (20 mm)	
8	8	107241	107101	107111	107131	107161	–	107201	–
6	13	107242	107102	107112	107132	107162	–	107202	–
4	19	107243	107103	107113	107133	107163	–	107203	–
2	32	107244	–	107114	107134	107164	–	107204	–
1	40	–	–	–	–	–	–	–	–
1/0	50	107246	–	107116	107136	107166	107186	107206	–
2/0	62	107247	–	107117	107137	107167	107187	107207	–
3/0	81	107248	–	–	–	107168	107188	107208	107228
4/0	103	107249	–	–	–	107169	–	107209	107229

Solder Accessories

Solder Pellets

- Color-coded solder pellets conform to industry standards & ensure correct product identification
- Pre-measured solder pellets assure the right amount of solder will be used in each connection
- Flux core prepares and cleans surfaces for soldering
- Easy to use, no need for crimping tools



6 GA / 4 GA
5530 / 5531

2 GA
5532

1 GA
5533

1/0
5534

2/0
5535

3/0
5536

4/0
5537

Use with GA size	Solder Pellets
6	5530
4	5531
2	5532
1	5533
1/0	5534
2/0	5535
3/0	5536
4/0	5537

Wire Solder

- Wire solder .125" diameter on a convenient spool
- Solid wire solder is 40% Tin and 60% Lead for optimum flowability
- VOC-Free formulation, non-flammable
- Melting point is 460°F

Soldering Paste Flux

- Rosin paste flux cleans and prepares surface for soldering
- Allows solder to flow deep into joints for superior bond
- Formulated for electronic, electrical, and industrial applications
- Low residue formula



Description	Part No.
Wire Solder, one pound spool	5571
Soldering Paste Flux, 4 oz jar	5572
QuickFlux Liquid Flux, 2 oz. bottle	5574

QuickFlux Liquid Flux

- Cleans and prepares surfaces for soldering
- Formulated for electronic, electrical, and industrial applications
- Used for Copper, Brass, and some steels
- VOC-Free formulation is non-hazardous and environmentally friendly
- Broad activity range an excellent choice for Tin/Lead, Tin/Silver, Tin/Bismuth, and Indium solder alloys

Lead-Free OEM Style B-Crimp Terminals

Lead Free ✓RoHS



Gauge	Positive	Negative
6 & 4	850109P	850109N
2 & 1	850211P	850211N

Lead Free with Auxillary ✓RoHS Take-Off



Gauge	Stud Size	Part No.
8, 6, 4, 2, 1	Universal – 5/16" stud	850105

Ring ✓RoHS



4-6 GA

Part No.	Stud Hole
850120D	1/4"
850120E	5/16"
850120F	3/8"
850120H	1/2"

1-2 GA

Part No.	Stud Hole
850220D	1/4"
850220E	5/16"
850220F	3/8"
850220H	1/2"

Left Ring Flag ✓RoHS



4-6 GA

Part No.	Stud Hole
850130D	1/4"
850130E	5/16"
850130F	3/8"
850130H	1/2"

1-2 GA

Part No.	Stud Hole
850230D	1/4"
850230E	5/16"
850230F	3/8"
850230H	1/2"

Right Ring Flag ✓RoHS



4-6 GA

Part No.	Stud Hole
850140D	1/4"
850140E	5/16"
850140F	3/8"
850140H	1/2"

1-2 GA

Part No.	Stud Hole
850240D	1/4"
850240E	5/16"
850240F	3/8"
850240H	1/2"

Marine Terminals

- Converts battery post to stud connector
- Permits quick disconnection from battery
- Polarity specific - meets U.S Coast Guard regulations



Description	Top Post to Stud Hole	Polarity	Part No.
Brass with tin plated steel fastener	5/16"	Positive	5013P
	3/8"		5014P
	5/16"	Negative	5015N
-	5517N		
Brass	-	Positive	5517P
Lead with zinc plated steel fastener	3/8"	Positive	5516P
Lead w/epoxy paint, zinc plated steel fastener	3/8"		5516R
Lead w/epoxy paint, zinc plated steel fastener	5/16"	Negative	5518B
Lead with tin plated steel fastener	5/16"		5518N

Universal Set Screw & Tie Bolt Terminal

- Universal Set Screw accepts 8 to 1 GA cable
- Tie Bolt accepts 6 to 1 GA cable



Description	Stud Hole	Polarity	Part No.
Set Screw: lead clamp with zinc plated, steel fastener	-	Universal	5506U
Tie Bolt: lead clamp with zinc plated, steel fastener			5502U
Set Screw: Lead side terminal with zinc plated, steel fastener	3/8"		5507U
Tie Bolt: Lead side terminal with zinc plated, steel fastener			5510U



Battery Terminals

Automotive, Heavy Duty

- Clamps designed for truck, bus, construction, agriculture and industrial applications
- Brass or lead construction, fasteners included
- OEM replacement

Description		Gauge	Polarity	Part No.
Automotive	Brass clamp	-	Universal	5588U
	Lead side terminal - 3/8" stud hole			5088U
	Lead clamp			5577U
	Lead clamp w/ black epoxy paint		Negative	5588B
	Lead clamp w/ red epoxy paint		Positive	5588R
Heavy Duty	Brass clamp	6 to 2/0	Negative	5066P
	Brass clamp		Negative	5067N
	Lead clamp	1 to 4/0	Universal	5566U



5577U



5588U



5566U



5088U



5067P



5588B



5588R

Military Style Connectors

- Exceeds military spec, positive #A52425-1 and negative #A52425-2



5349N



5350P

Description	Polarity	Part No.
Lead, military style connector with zinc plated, steel fastener	Negative	5349N
Lead, military style connector with zinc plated, steel fastener	Positive	5350P

3-Way Connectors



850151



850161

Description	Polarity	Part No.
6 - 1 GA 3-way top post connector	Negative	850151
2 - 4/0 GA 3-way top post connector		850161
6 - 1 GA 3-way top post connector	Positive	850150
2 - 4/0 GA 3-way top post connector		850160

Right Angle Heavy Duty Brass Terminals



Description	Polarity	Part No.
2 GA - 2/0 right angle HD brass terminal	Negative	5567N
2 GA - 2/0 right angle HD brass terminal	Positive	5567P

Quick Disconnect



850119



850113



850118



850112

Description	Polarity	Part No.
Top post, copper, brass and zinc plated terminal, steel fastener	Negative	850112
Side terminal, copper, brass plated zinc plated, steel fastener	Universal	850113
Top post, copper, bright tin plating terminal, steel fastener	Negative	850118
Side terminal, copper, bright tin plating, steel fastener	Universal	850119

Battery Terminal Adapters

Adapter for Japanese Industrial Standard (Pencil Post)



Description	Polarity	Part No.
Battery post adapter for JIS ("pencil post")	Negative/Positive	108406

Stud-to-Post Conversion



Description	Part No.
5/16" conversion – set of pos. & neg.	5513
3/8" conversion – set of pos. & neg.	5514

Side Terminal-to-Post Conversion



Description	Part No.
Conversion – set of pos. & neg.	5515

SAE to Japanese Industrial Standard (Pencil Post) Conversion



Description	Part No.
SAE to pencil post conversion – neg.	850250
SAE to pencil post conversion – pos.	850350

Battery Post Shims



Description	Part No.
Battery post shims	850115

Top Post-to-Side Terminal Connectors



Description	Part No.
TP to ST connector – negative	5519
TP to ST connector – positive	5521
TP to ST connector – pair	5520

Specialty Terminal with Flag-to-Top Post



Description	Part No.
Flag to top post conversion	850116

Adapter Bushings



Bushing Size	Fits Terminal	Part No.
4 GA	2/0	6053
2 GA	2/0	6054
1 GA	2/0	6055

Adapter Bolts and Nuts



6007

6008

6024

6025

























6029

Accessory Post Adapter Descriptions	Measurements	Material	Part No.
Adapter bolt, side terminal accessory post for single power lead	3/8" - 16 x 3/8" accessory stud: 5/16" - 18 x 1/2"	Brass; zinc plated steel fastener	6007
Adapter bolt, side terminal accessory post for double power lead	3/8" - 16 x 15/16" accessory stud: 5/16" - 18 x 1/2"	Brass; zinc plated steel fastener	6008
Adapter nut, top terminal accessory post	5/16" - 18 x 9/16", inside thread; accessory stud: 5/16" - 18 x 9/16"	Brass; zinc plated steel fastener	6024
Adapter nut, top terminal accessory post	1/4" - 20 x 9/16", inside thread; accessory stud: 5/16" - 18 x 9/16"	Brass; zinc plated steel fastener	6025
Adapter nut, top terminal accessory post	3/8" - 16 x 3/4", inside thread; accessory stud: 3/8" - 16 x 3/4"	Brass; zinc plated steel fastener	6029

Fastener Hardware

- For Battery Applications



	Description	Material	Part No.	
	1/4"-20 x 1-5/8", OEM type Bolt, square head & shoulder nut, oil-treated	Steel	6011	
	5/16"-18 x 1-1/4" Bolt, square head & shoulder nut, tin-plated		6014	
	5/16"-18 x 1-1/4" Bolt, square head & nut, zinc-plated		6000	
	1/4"-20 x 3/4" Bolt, hex head & nut, zinc-plated		106200	
	5/16"-18 x 1-1/4", Red Bolt, square head & shoulder nut, QuickCote™ treated		6698R	
	5/16"-18 x 1-1/4", Black Bolt, square head & shoulder nut, QuickCote™ treated		6698B	
	5/16"-18 x 1-1/2" Bolt, square head & shoulder nut, zinc-plated		6712	
	3/8"-16 x 2", Mil spec Bolt, square head & nut, tin-plated		6019	
	3/8"-16 x 15/32" Bolt, side terminal, for single power lead, zinc-plated		6733	
	3/8"-16 x 13/32" Bolt, side terminal, for single power lead, OEM type, zinc-plated		6703	
	3/8"-16 x 1" Bolt, side terminal, for dual power lead, OEM type, zinc-plated		6704	
	3/8"-16 nut, self locking Flange, zinc-plated		6708	
	5/16"-18 nut Shoulder, tin-plated		6701T	
	3/8"-16 nut Closed cap, stainless steel	Stainless Steel	6015	
	3/8"-16, red nut Closed cap, powder coated		6016R	
	3/8"-16, black nut Closed cap, powder coated		6016B	
	1/4"-20, wing nut For hold-down bolt, zinc-plated	Steel	6734	
	5/16"-18, wing nut Forged steel, tin-plated		106115	
	3/8"-16, wing nut Forged steel, tin-plated		106116	
	5/16"-18, hex nut Steel, zinc-plated		106125	
	3/8"-16, hex nut Steel, zinc-plated		106126	
	Spacer for 6704 dual power lead, side terminal bolt Also fits 6008 dual power lead accessory post adapter		Lead	6706
	1/4" washer Fender, Use with 6734 wing nut for hold-down applications		Steel	6753
	5/16" washer zinc-plated			6756
	3/8" washer zinc-plated			6758

GARDIAN™

Solderless Heat Shrink Terminals

- For harsh applications rated 600V
- Integral meltable sealant locks out moisture, corrosive salts and fumes
- Highest quality heat-shrink solderless terminals for use in demanding auto, truck, bus, agriculture, construction or industrial applications
- Polyolefin heat-shrink insulation provides long lasting strain relief from vibration
- Temperature range rated to + 167° F (+75° C)

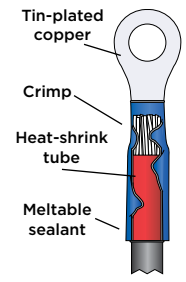

Ring



Stud Tab Size	Wire GA	Color	Part No.
#6	22-18	Red	164102
			164103
			164104
			164105
			164106
			164107
#8	16-14	Blue	164202
			164203
			164204
			164205
			164206
			164207
#10	12-10	Yellow	164403
			164404
			164405
			164406
			164407
			164408

Spade



Stud Tab Size	Wire GA	Color	Part No.
#6	22-18	Red	164124
			164125
			164126
#8	16-14	Blue	164224
			164225
			164226
#10	12-10	Yellow	164425
			164426
			164427

Butt Connector



Wire GA	Color	Part No.
22 - 18	Red	164180
16 - 14	Blue	164280
12 - 10	Yellow	164480
8	Red	164580

Female Disconnect



Stud Tab Size	Wire GA	Color	Part No.
.250	22 - 18	Red	164148
	16 - 14	Blue	164248
	12 - 10	Yellow	164448

Male Disconnect



Stud Tab Size	Wire GA	Color	Part No.
.250	22 - 18	Red	164153
	16 - 14	Blue	164253
	12 - 10	Yellow	164453

Fully Insulated Female Disconnect



Stud Tab Size	Wire GA	End View	Color	Part No.
.250	22 - 18		Red	164158
	16 - 14		Blue	164258
	12 - 10		Yellow	164458

Fully Insulated Male Disconnect



Stud Tab Size	Wire GA	End View	Color	Part No.
.250	22 - 18		Red	164160
	16 - 14		Blue	164260
	12 - 10		Yellow	164460

Female Bullet



Stud Tab Size	Wire GA	Color	Part No.
.157	22 - 18	Red	164166
	16 - 14	Blue	164266
.195	12 - 10	Yellow	164468

Male Bullet



Stud Tab Size	Wire GA	Color	Part No.
.157	22 - 18	Red	164170
	16 - 14	Blue	164270
.195	12 - 10	Yellow	164472

Premium Nylon Double Crimp Terminals

- For harsh applications rated 600V
- Designed for heavy-duty applications to resist vibration and moisture
- Kits with these parts are listed in the following section.
- Temperature range, -67°F to + 221°F (-55°C to +105°C)

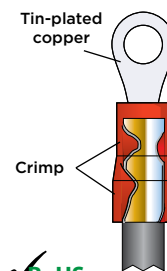

Nylon Ring Double Crimp



Stud Tab Size	Wire GA	Color	Part No.
#4 - 6	22-18	Red	163102
#8			163103
#10			163104
5/16"			163105
1/4"			163106
#6	16-14	Blue	163202
#8			163203
#10			163204
1/4"			163205
5/16"			163206
3/8"	12-10	Yellow	163207
#8			163403
#10			163404
1/4"			163405
5/16"			163406
3/8"	163407		
1/2"	163408		

Spade Double Crimp



Stud Tab Size	Wire GA	Color	Part No.
#8	22-18	Red	163125
	16-14	Blue	163225
#10	12-10	Yellow	163425
		Yellow	163426

Butt Connector



Wire GA	Color	Part No.
22 - 18	Red	163180
16 - 14	Blue	163280
12 - 10	Yellow	163480

Female Disconnect



Stud Tab Size	Wire GA	Color	Part No.
.110	22-18	Red	163145
.187			163146
.250			163148
.187	16-14	Blue	163246
.250			163248
	12-10	Yellow	163448

Male Disconnect



Stud Tab Size	Wire GA	Color	Part No.
.250	22 - 18	Red	163153
	16 - 14	Blue	163253
	12 - 10	Yellow	163453

Insulated Female Disconnect



Stud Tab Size	Wire GA	End View	Color	Part No.
.187	22-18		Red	163157
.250			163158	
.187			163257	
.250	16-14		Blue	163258
			Yellow	163458

Insulated Male Disconnect



Stud Tab Size	Wire GA	End View	Color	Part No.
.250	22 - 18		Red	163160
	16 - 14		Blue	163260
	12 - 10		Yellow	163460

Insulated Female Bullet



Stud Tab Size	Wire GA	Color	Part No.
.078	22 - 18	Natural	163069
.157		Red	163166
		16 - 14	Blue

Insulated Bullet Male



Stud Tab Size	Wire GA	Color	Part No.
.078	22 - 18	Natural	163073
.157		Red	163170
		16 - 14	Blue

PVC Terminals

- For general purpose applications
- Tin-plated, annealed copper for improved corrosion resistance, max conductivity and crimp strength
- Rated 600V
- Operating temperature range from -67°F to +221°F (-55°C to +105°C)

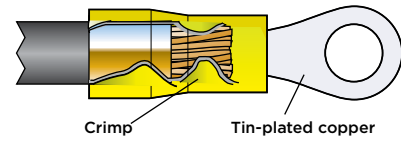

Spade



Stud Tab Size	Wire GA	Color	Part No.
#6	22-18	Red	160124
#10			160126
#6			160224
#8	16-14	Blue	160225
#10			160226
#6			160424
#8	12-10	Yellow	160425
#10			160426

Locking Spade



Stud Tab Size	Wire GA	Color	Part No.
#6	22-18	Red	160130
#8			160131
#10			160132
#6	16-14	Blue	160230
#8			160231
#10			160232
#8	12-10	Yellow	160431
#10			160432

Ring



Stud Tab Size	Wire GA	Color	Part No.
#4	22 - 18	Red	160101
#6			160102
#8			160103
#10			160104
1/4"			160105
5/16"			160106
3/8"			160107
#4	16-14	Blue	160201
#6			160202
#8			160203
#10			160204
1/4"			160205
5/16"			160206
3/8"			160207
1/2"	160208		
#6	12-10	Yellow	160402
#8			160403
#10			160404
1/4"			160405
5/16"			160406
3/8"			160407
1/2"			160408
#10	8	Red	160504
1/4"			160505
5/16"			160506
3/8"	160507		
#10	6	Blue	160604
1/4"			160605
5/16"			160606
3/8"			160607

Flange Spade



Stud Tab Size	Wire GA	Color	Part No.
#6	22-18	Red	160134
#8			160135
#10			160136
#6	16-14	Blue	160234
#8			160235
#10			160236
#8	12-10	Yellow	160435
#10			160436

Heavy Duty Ring



Stud Tab Size	Wire GA	Color	Part No.
#8	14 - 12	Black	160303
#10			160304
1/4"			160305

Multi-Stud Ring



Stud Tab Size	Wire GA	Color	Part No.
#6, #8, #10	22 - 18	Red	160112
	16 - 14	Blue	160212
	12 - 10	Yellow	160412

Hook  



Stud Tab Size	Wire GA	Color	Part No.
#6	22-18	Red	160138
#8			160139
#10			160140
#6	16-14	Blue	160238
#8			160239
#10			160240
#8	12-10	Yellow	160439
#10			160440

Bullet Male  



Stud Tab Size	Wire GA	Color	Part No.
.157	22-18	Red	160170
.180			160171
.157	16-14	Blue	160270
.180			160271
.195	12-10	Yellow	160472

Bullet Female  



Stud Tab Size	Wire GA	Color	Part No.
.157	22-18	Red	160166
.180			160167
.157	16-14	Blue	160266
.180			160267
.195	12-10	Yellow	160468

Male Disconnect 



Stud Tab Size	Wire GA	Color	Part No.
.110	22-18	Red	160150
.187			160151
.250	16-14	Blue	160153
.187			160251
.250	12-10	Yellow	160453

Female Disconnect 



Stud Tab Size	Wire GA	Color	Part No.
.110 	22-18	Red	160145
.187 			160146
.205 			160147
.250 			160148
.110 	16-14	Blue	160245
.187 			160246
.205 			160247
.250 			160248
.375 	12-10	Yellow	160249
.187 			160446
.250 			160448
.375 	160449		

3-Way Connector 



Wire GA	Color	Part No.
22 - 18	Red	160178
16 - 14	Blue	160278
12 - 10	Yellow	160478

4-Way Connector 



Wire GA	Color	Part No.
22 - 18	Red	160179
16 - 14	Blue	160279
12 - 10	Yellow	160479

Butt Connector 



Wire GA	Color	Part No.
22 - 18	Red	160180
8		160580
16-14	Blue	160280
6		160680
12-10	Yellow	160480

Parallel Butt Connector  



Wire GA	Color	Part No.
22 - 18	Red	160181
16 - 14	Blue	160281
12 - 10	Yellow	160481

Piggyback Disconnect



Stud Tab Size	Wire GA	Color	Part No.
.250	22 - 18	Red	160163
	16 - 14	Blue	160263
	12 - 10	Yellow	160463

Stepdown Butt Connector



Wire GA	Part No.
16 - 14 / 18 - 22	160183
12 - 10 / 16 - 14	160283
8 / 12 - 10	160483

Pin Terminal



Stud Tab Size	Wire GA	Color	Part No.
.075	22 - 18	Red	160175
	16 - 14	Blue	160275
	12 - 10	Yellow	160475

Quick Tap Connector



Wire GA	Color	Part No.
22 - 18	Red	160185
16 - 14	Blue	160285
16 - 14	White	160286*
12 - 10 / 18 - 14	Brown	160287
12 - 10	Yellow	160485

T-Tap Connector - .250



Wire GA	Color	Part No.
22 - 18	Red	160188
16 - 14	Blue	160288
12 - 10	Yellow	160488

Bullet Tap Splice - .250



Wire GA	Color	Part No.
16 - 14	Blue	160289

*With no stop.

Nylon Terminals

- Rated 300V
- Tin plated copper
- Operating temperature range from -67°F to +221°F (-55°C to + 105°C)

Nylon Insulated Female Disconnect



Stud Tab Size	Wire GA	End View	Color	Part No.
.250	22 - 18		Red	162158
	16 - 14		Blue	162258
	12 - 10		Yellow	162458

Nylon Insulated Male Disconnect



Stud Tab Size	Wire GA	End View	Color	Part No.
.250	22 - 18		Red	162160
	16 - 14		Blue	162260
	12 - 10		Yellow	162460

Flag Terminal Insulated



Stud Tab Size	Wire GA	Color	Part No.
.250	22 - 18	Red	162165
	16 - 14	Blue	162265

Nylon Butt Connector - Flared Ends



Wire GA	Color	Part No.
22 - 18	Red	162180
16 - 14	Blue	162280
12 - 10	Yellow	162480

Premium Nylon Solderless Kit

- Premium quality heat shrink solderless terminals for use in demanding auto, truck, bus, agriculture, construction, or industrial applications
- Integral meltable sealant locks out moisture, corrosive salts, and fumes
- Tin plated copper connectors with polyolefin heat-shrink insulation



Description	Part No.
Gardian and PVC 650 pcs.	164900
11 styles of terminal 33 pcs.	164901
10 styles of terminal 65 pcs.	164902
3 styles of butt connector 125 pcs.	164905

Specialty Terminals and Connectors



169101

169103

169105,
169107

169108,
169112

Wire Gauge	Description	Part No.
.156	2-way female receptacle	169101
.250	Double male tab receptacle	169103
22-18	Closed end flat connector	169105
16-14	Closed end flat connector	169106
12-10	Closed end flat connector	169107
8	Closed end connector	169108
22-18	Closed end connector	169110
16-14	Closed end connector	169111
12-10	Closed end connector	169112

Lead-Free Butt Connectors

- Provide a high quality, secure, sealed connection
- Soldered terminations provide superior strength and conductivity
- Heat shrink with meltable adhesive seals the connections
- RoHS compliant solder
- See Heavy Duty Ratchet Crimp Tool for heat shrink terminals (165800)
-The crimper designed exclusively for heat shrink crimpable terminals
- All single butt connectors are sold in bags of 25 or 100 pcs. Order using -025 or -100
- Melting temperature, 138°C (280°F)
- Operating temperature, -55°C (-67°F) to 110°C (230°F)

Lead-Free Solder Shrink Butt Connectors

NEW!



Wire GA	Color	Part No.
22 - 18	Red	165500
16 - 14	Blue	165501
12 - 10	Yellow	165502
8 AWG	Red	165503



NEW!

Wire GA	Part No.
22-18, 16-14, 12-10	165505

Lead-Free Crimp Solder Shrink Butt Connectors ✓RoHS

- See Heavy Duty Ratchet Crimp Tool for heat shrink terminals (165800) -The crimper designed exclusively for heat shrink crimpable terminals



NEW!

Wire GA	Color	Part No.
22 - 18	Red	165600
16 - 14	Blue	165601
12 - 10	Yellow	165602



NEW!

Wire GA	Part No.
22-18, 16-14, 12-10	165605

Lead-Free Crimp Solder Shrink Stepdown Butt Connectors ✓RoHS

- Step-down butt connectors act as a reducer
- Connects two different gauges of wires conductively
- See Heavy Duty Ratchet Crimp Tool for heat shrink terminals (165800) -The crimper designed exclusively for heat shrink crimpable terminals



NEW!

Wire GA	Color	Part No.
22 - 18	Red	165606
16 - 14	Blue	165607
12 - 10	Yellow	165608

Fusion® Butt Connectors

- Controlled soldering combined with heat-shrink tubing in one step
- Rated 600V, 230°F (110°C)
- Transparent sleeves with color-coded sealing rings easy to inspect
- Check out our Ratchet Crimp Tool for Heat Shrink Terminals

Solder Heat Shrink Butt Connectors



Wire GA	Color	Part No.
22 - 18	Red	165181
16 - 14	Blue	165281
12 - 10	Yellow	165481

Solder Heat Shrink Butt Connectors Kit

- Kit contains 125 pieces, 3 styles of butt connectors



Wire GA	Part No.
12-10, 16-14, 20-18	165905

Solderless Terminal Kit

PVC Solderless Connector Kits  

- Quality terminals for years of dependable service
- Tin-plated, annealed copper for improved corrosion resistance, max conductivity and crimp strength
- Ridged PVC sleeves for improved abrasion resistance

No. of Pieces	Types of Terminals	Tools	Part No.
175	18 types	no tool	160900
600	24 types	no tool	160901
1675	full assortment of PVC terminals	no tool	160902
100	16 types	includes tool	160903
295	18 types	includes tool	160904
250	3 styles of butt connectors	no tool	160905



160904



160902



160903

OEM Non-Insulated Solderless Terminals

- Tin-plated, annealed copper for improved corrosion resistance, maximum conductivity and crimp strength
- Serrated barrels for greater wire retention/pullout strength

Ring 



Stud Tab Size	Wire GA	Part No.
#6	22-18	166102
#8		166103
#10		166104
1/4"		166105
5/16"		166106
#6	16-14	166202
#8		166203
#10		166204
1/4"		166205
5/16"		166206
3/8"	166207	
#8	12-10	166403
#10		166404
1/4"		166405
5/16"		166406
3/8"		166407

Male Disconnect 



Stud Tab Size	Wire GA	Part No.
.250	22 - 18	166153
	16 - 14	166253
	12 - 10	166453

Female Disconnect 



Stud Tab Size	Wire GA	Part No.
.250	22 - 18	166148
	16 - 14	166248
	12 - 10	166448

Spade ✓RoHS



Stud Tab Size	Wire GA	Part No.
#8	22-18	166125
#10		166126
#8	16-14	166225
#10		166226
#8	12-10	166425
#10		166426

Flag Female Disconnect ✓RoHS



Stud Tab Size	Wire GA	Part No.
.250	22 - 18	166165
	16 - 14	166265

Butt Connector ✓RoHS



Wire GA	Part No.
22 - 18	166180
16 - 14	166280
12 - 10	166480

Seamless Butt Connector ✓RoHS



Wire GA	Part No.
22 - 18	167180
16 - 14	167280
12 - 10	167480



Non-Insulated Solderless

Disconnect Adapters ✓RoHS

- Mount is pictured above tin plated annealed copper for improved corrosion resistance, maximum conductivity and crimp strength
- Serrated barrels for greater wire retention/pullout strength



Stud Tab Size	Description	Part No.
.250	Male/female/male	169135
.250/#10	Male/#10 stud hole	169137
.250	Female/dual male	169136
.250/#10	Male/#10 stud hole	169138
.250	Dual male/90°/female	169139

Weather Pack

OEM Terminals, Housings and Seals ✓RoHS

- Nylon housings rated at -50°F to +262°F (-46°C to +128°C)
- Ideal for engine compartment and other harsh environment use
- Seals out water and moisture
- Terminals have lock tabs that snap into housing cavity and are tin-plated
- Silicone seals and plugs have multiple ribs to form positive seal in housing cavity

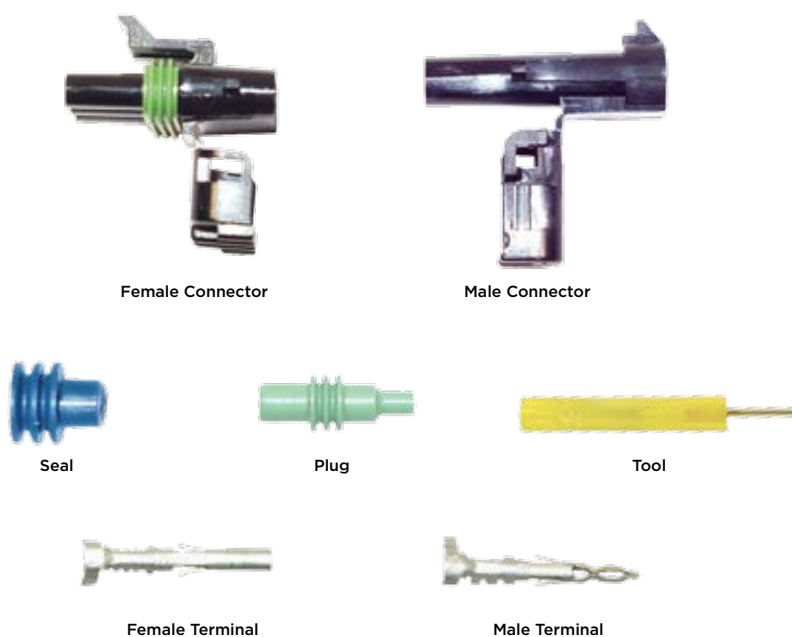

Description	Part No.
1-way female connector	6150
1-way male connector	6151
2-way female connector	6152
2-way male connector	6153
3-way female connector	6154
3-way male connector	6155
4-way female connector	6156
4-way male connector	6157
6-way female connector	6158
6-way male connector	6159
20 - 18 GA, male terminal	6160
20 - 18 GA, female terminal	6161
16 - 14 GA, male terminal	6162
16 - 14 GA, female terminal	6163
12 GA, male terminal	6164
12 GA, female terminal	6165
20 - 18 GA, seal	6166
16 - 14 GA, seal	6167
12 GA, seal	6168
Plug	6169
OEM terminal extractor tool	420191

WIRE & CABLE

- Battery Cable.....33-35
- Welding Cable35
- DLO RHH/RHW Cable36
- Machine Tool Wire36
- Rescue® Booster Cable37
- Rescue® Booster Clamps & Accessories 38-39
- Booster Cable 40
- Cables for Commercial & Industrial.....40-41
- Overmolded Group 31 Battery Assemblies 41
- Multi-Battery Assemblies..... 42-43
- Aftermarket Pre-Made Automotive Cables 43
- Quick® Replacement Ends.....44-45
- Golf Cart Cables..... 46
- Primary Wire 47-48
- Multi-Conductor Flat Jacketed..... 48
- Jacketed Marine Wire 48
- Parallel Bonded 49
- Control Cable.....49-50
- Trailer Cable 50
- Continuous Loop & Truck Kits51
- Portable Cord51
- Braided Group Straps52-53



Battery Cable

Quick® Color Code System

- Quick and easy identification of the cable gauge is provided
- Color code matches the cable to the connector
- The color stripe helps you measure the length of your cable
- Available in 10, 25, 50, 100, 250, 500 ft rolls



Cable Gauge Sizing

- The size bullets shown will help you determine the GA (size) of an unmarked starter cable
- Measure the bare conductor only, not the insulation
- Actual diameters will vary depending on specific wire stranding

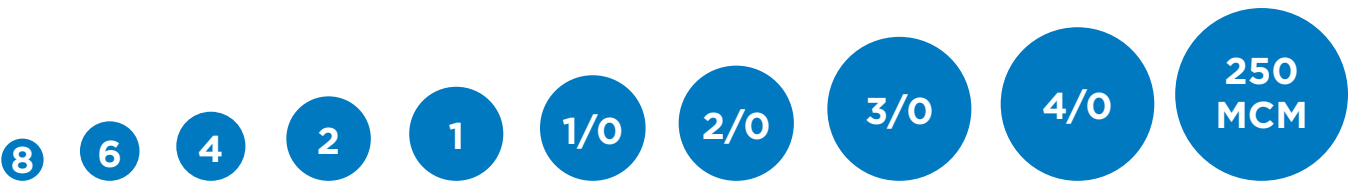

Metric and AWG Wire Size

Metric values are expressed as nominal values and vary by country

mm ²	3	5	8	13	19	32	40	50	62	81	103	126
AWG	12	10	8	6	4	2	1	1/0	2/0	3/0	4/0	250 MCM

Standard Battery Cable

- Rated 60V
- PVC insulation resists abrasion, fuel, oil, acid and salt
- Insulation is flame-retardant
- Copper conductor for maximum conductivity
- Meets or exceeds SAE J1127, SGT type
- 8 gauge meets J1128
- Temperature range: 221°F (105°C) to -58°F (-50°C)



GA	Color-Coded Stripe	Black	Red
8	Gray	200101	200201
6	Gray	200102	200202
4	Gray	200103	200203
2	Green	200104	200204
1	Pink	200105	200205
1/0	Black	200106	200206
2/0	Orange	200107	200207
3/0	Purple	200108	200208
4/0	Yellow	200109	200209

Fine Stranded Battery Cable

- Rated 600V
- Superior, high performance battery cable for auto/truck, marine, industrial and back-up power applications
- Fine stranded, annealed bare copper wire
- Copper conductor for maximum conductivity
- Oil, water, acid resistant (SGT) thermoplastic rubber compound
- Water resistant safety insulator/separator for additional protection against corrosion or cut through
- More flexible than standard battery cable
- Excellent low temperature flexibility
- High resistance to UV light and ozone exposure
- Meets SAE J378C/J1127
- Meets UL 62 for SJE, SE, and SEO
- Applications: battery cable, jumpers, starters, ground, marine rating
- Temperature range: 221°F (105°C) to -58°F (-50°C)



GA	Black	Red
6	201702	201802
4	201703	201803
2	201704	201804
1	201705	201805
1/0	201706	201806
2/0	201707	201807

UL® Marine Battery Cable

- Rated 600V
- Enhanced oil, fuel and acid resistance
- PVC insulation
- Highly abrasion-resistant
- UL listed BC-5W2 boat cable
- Fine-stranded copper conductor, tin-plated, for maximum conductivity, flexibility and corrosion resistance
- Temperature range: 221°F (105°C) to -4°F (-20°C)



GA	Black	Red
8	200501	200601
6	200502	200602
4	200503	200603
2	200504	200604
1	200505	200605
1/0	200506	200606
2/0	200507	200607
3/0	200508	200608
4/0	200509	200609

SGX Battery Cable

- For high temperature applications
- Annealed, bare copper conductor, more flexible
- Chemically cross-linked polyolefin (XLPO) insulation
- Available certifications:
 - SAE: J1654
 - Ford: ESB-M1L85-A, ESF-M1L92-A
 - Chrysler: MS-5919
 - Delphi: ESM-3024
- Temperature range: 257°F (125°C) to -40°F (-40°C)



GA	Black	Red
6	205102	205202
4	205103	205203
2	205104	205204
1/0	205106	205206
2/0	205107	205207
3/0	205108	205208
4/0	205109	205209

Welding Cable

QuickFlex®

- Rated 600V
- Abrasion, salt, and chemical-resistant synthetic rubber insulation
- Fine-stranded copper conductor for maximum conductivity and flexibility
- Good flame resistance
- Temperature range: 221°F (105°C) to -58°F (-50°C)



GA	Black	Red
6	202102	202202
4	202103	202203
2	202104	202204
1	202105	202205
1/0	202106	202206
2/0	202107	202207
3/0	202108	202208
4/0	202109	202209
250 MCM	202110	-

QuickFlex® Tinned Welding Cable

- Rated 600V
- Abrasion salt and chemical-resistant synthetic rubber insulation
- Meets UL3284, CSA CL1254, AWG specifications
- Fine-stranded tinned copper conductor for maximum conductivity, flexibility and corrosion resistance
- Excellent flame resistance
- Temperature range: 257°F (125°C) to -4°F (-20°C)



GA	Black
6	203102
4	203103
2	203104
1	203105
1/0	203106
2/0	203107
3/0	203108
4/0	203109

DLO RHH/RHW Cable

- Rated 600V and 2000V
- Fine stranded, annealed, tinned copper wire in accordance with AAR-598 and ASTM B33
- Maximum conductivity, flexibility and corrosion resistance
- EPR (Ethylene Propylene Rubber) insulation, highly resistant to oils, alkalis and acids
- VW-1 rated, flame retardant
- UV sun resistant
- Industry Approvals: ICEA S-95-685/NEMA WC 70; UL 44 Type RHH/RHW-2 C (UL) RW90, MSHA - rated flame retardant; CSA RW90 at 1,000 Volts
- REACH compliant; approved for CT use (2/O and larger)
- NEC suitable as flexible wiring in open air trays, trays or conduit
- Applications: telecom power supply systems, mining, industrial and earth moving equipment, motor leads, diesel electric locomotive, where flexible power leads must be installed in conduit or raceways
- Handles well for wet/dry continuous exposure
- Temperature range: 221°F (105°C) to -40°F (-40°C)



GA	Nomimal		Lbs./Foot	Part No.
	Insulation	O.D.		
2/O	0.09	0.68	0.56	208107
3/O		0.75	0.67	208108

Machine Tool Wire (MTW)

- Rated 600V
- Fine stranded, annealed, bare copper wire
- PVC (polyvinyl chloride) insulation, tough, moisture and chemical resistant (acid, diesel fuel, oil)
- VW-1 rated, flame retardant
- Industry Approvals: 6 - 2 AWG: UL 1232/1283/1346/10269; 1, 1/O - 4/O AWG: 1232/1284/1338/10269; 250-500MCM:1284/1339/10269
- Applications: recommended for wiring in uninterrupted power supplies, machine tools, appliances, transformers, switchboard panels, controls, electronic circuits and meters; can be used as battery cable, motor lead and power hook-up cable
- Temperature range: UL and CSA 221°F (105°C) to -58°F (-50°C)



GA	Nomimal		Lbs./Foot	Part No.
	Insulation	O.D.		
8	0.04	0.25	0.07	203301
6		0.32	0.12	203302
4	0.06	0.38	0.17	203303
2		0.44	0.26	203304
1	0.08	0.51	0.33	203305
1/O		0.56	0.41	203306
2/O		0.62	0.51	203307
3/O		0.68	0.64	203308
4/O		0.76	0.79	203309
250 MCM	0.09	0.83	0.91	203311
350 MCM	0.10	0.95	1.51	203312
500 MCM	0.11	1.12	1.97	203313



RESCUE® Booster Cables

All Booster Cables Include:

- Fine-stranded copper conductor for maximum conductivity and flexibility
- Tangle-proof construction
- Stays flexible in subzero temperatures

Automotive

- Complete illustrated instructions
- Best for light duty applications
- Retail packaging for automotive sales



Storage box

Retail sleeve

GA	Length	Clamp Amps	Clamp Style	Pkg.	Part No.		
10	8'	150	Alligator	Sleeve	602100		
8		200			602110		
6	12'				602120		
					602140		
6	16'				400	Mechanic	Bag
		602160					

Medium Duty

- Complete illustrated instructions
- Best for light duty applications
- Retail packaging for automotive sales



Zippered vinyl weatherproof bag with carry handle

GA	Length	Clamp Amps	Clamp Style	Pkg.	Part No.
4	12'	400	Mechanic	Bag	602170
		500	Parrot	Box	602222 602224
	16'	400	Mechanic	Bag	602203
		500	Coated Parrot	Box	602200
	20'	400	Mechanic	Bag	602205
		500	Parrot	Box	602226
2	12'	500	Mechanic	Bag	602220
			16'	Mechanic	Bag
	Parrot			Box	602271
	20'		Mechanic	Bag	602280
			Coated Parrot	Box	602281
	Parrot		602282		

Heavy Duty

- Solid copper 900-amp clamps on 1/0 gauge and larger
- Use with heavy duty equipment
- Reusable/waterproof pail for 1 GA/25' and larger



Durable, black, weatherproof storage pail with cover

GA	Length	Clamp Amps	Clamp Style	Pkg.	Part No.	
1	12'	500	Mechanic	Bag	602310	
	16'				602320	
	20'				602330	
	20'		500	Parrot	Box	602332
						602345
	25'		900	Parrot	Pail	602340
						25'
30'	500	Mechanic	602360			
			602370			
1/0	20'	900	Parrot	602380		
2/0	25'			602390		
	30'			602400		
2/0	40'			602410		
	602420					

RESCUE® Booster Clamps & Accessories

Booster Clamps - Four Styles



Clamp Style	Amps	Package	Part No.
Alligator	200	Pair	602045
Mechanic	400		602050
	500		602060
Coated Parrot			602065
Parrot	602055		

900 - Amp Solid Copper

- Solid copper 900-amp parrot clamps
- Sold in pairs or singles
- Hardware included
- Black and red rubber grips
- Also available in bulk



Amps	Clamp Style	Package	Part No.
900	Parrot	Pair	602070
	Parrot - black	Single	602071
	Parrot - red		602072

1000 - Amp Solid Copper

- Solid brass jaws and body
- 100% copper bonding strap powering both jaws
- Detachable brass crimp lug for ease of assembly
- Use with 1/0 and larger cables
- Heavy duty hardware included



602058K

Amps	Clamp Style	Package	Part No.
1000	Mechanic	Pair	602058K
	Mechanic - black	Single	602058R
	Mechanic - red		602058B

Charging Clips - Six Styles



Charging Clip Style	Features	Amps	Part No.
Alligator with banana plug Pack qty. 1 pair	<ul style="list-style-type: none"> • Also fits 16-14 GA bullet connector • Vinyl insulation boots shield exposed metal • Use to build custom test leads of any length 	5	602005
Non-insulated alligator Pack qty. 1 pair		5	602007
Alligator with vinyl boots Pack qty. 1 pair		5	602010
Charging with vinyl boots Pack qty. 1 pair	<ul style="list-style-type: none"> • Jaws grasp terminal bolts, etc., to 3/4" wide 	10	602020
Jaw-type charging Pack qty. 1 pair	<ul style="list-style-type: none"> • Jaws grasp terminal bolts, etc., to 3/4" wide • 10, 25 and 50-amp 	10	602021
		25	602030
		50	602036
Heavy duty charging Pack qty. 1 pair	<ul style="list-style-type: none"> • 50 and 75 amp capacity exceeds most on market • Boots protect crimp ears 	50	602035
		75	602040

Two Ways to Use Plug-In Booster Cables:

GA	Clamp Amp	1 Clamp-to-Plug	3 5' Plug-to-Lug	1 + 3 Combo Kit
4	400	602580 (15')	602620	602500 (20')
		602585 (25')		602510 (30')
2	500	602590 (15')	602630	602520 (20')
		602600 (25')		602630 (30')
1/0	800	602610 (25')	602640	602640 (30')

Parallel bonded for tangle-free service

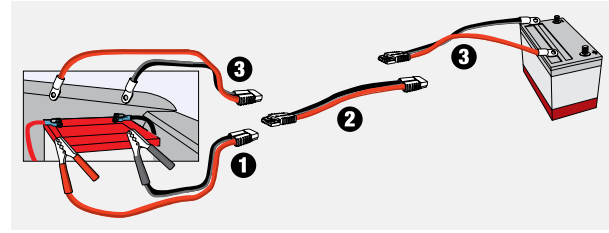

A. Two-Part Booster Set

- Permanently install plug-to-lug cable 3 in service vehicle
- Use clamp-to-plug cable 1 to jump dead vehicle battery
- Advantage: Store clamp-to-plug cable 1 in cab of service vehicle to reduce risk of theft, loss or damage

B. System Using Plugs Only

- Permanently install plug-to-lug cable 3 in service vehicle as well as in every fleet vehicle
- Use plug-to-plug cable 2 as a foolproof, polarity-specific booster cable between service vehicle and fleet vehicle battery
- Advantage: eliminates need to open hood, greatly reducing risk of battery explosion and shields both engine and battery from rain or snow

Plug-Ins

- Fine-stranded copper conductor for maximum conductivity and flexibility
- Parallel bonded cables resist tangling, remain flexible in cold weather

Cable 1 Clamp-to-Plug



GA	Length	Rating	Part No.
4	15'	400 amp	602580
	25'		602585
2	15'	500 amp	602590
	25'		602600
1/0	25'	800 amp	602610

Cable 2 Clamp-to-Plug



GA	Length	Rating	Part No.
4	12'	175 amp	602550
2			602560
1/0			602570

Cable 3 Clamp-to-Plug



GA	Length	Rating	Part No.
4	5'	175 amp	602620
2			602630
1/0			602640

Surge Protectors

- Provides electronic surge protection without disconnecting the battery
- Clip booster clamps across the battery, when the green LED is illuminated, the system is protected from spikes while the vehicle is being worked on
- Designed for heavy duty applications weatherproof and shockproof housing
- Green indicates protection, red no protection



Description	Part No.
12-volt surge protector	602700
24-volt surge protector	602705

Booster Cable

Twin Conductor

- Can be used with SB® type connectors for plug in convenience
- Abrasion-resistant
- Insulation stays flexible in cold weather
- Bonded cable resists tangling
- Color-coded for polarity identification
- Rated 60V
- Fine-stranded copper conductor for maximum conductivity and flexibility
- Temperature range: 221°F (105°C) to -40°F (-40°C)



GA	Part No.	Colors	
6	204102	Orange	Black
4	204103	Yellow	
2	204104	Red	
1	204105	Gray	
1/0	204106	Black with red tracer	

Cables for Commercial & Industrial Equipment

Typical 12V Battery Layouts, Parallel and Series

- Use power cables to connect batteries to starter or ground

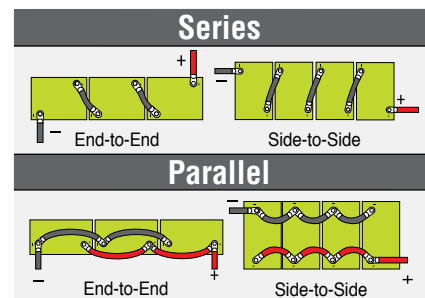
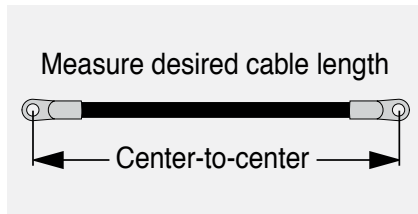

QuickLinks® & Input/Output Cables ✓RoHS

- Engineered for commercial and industrial equipment
- Ideal for 6 or 12-volt batteries such as, GC2, Group 24, Group 27, etc.
- UL/CSA components should be used when equipment is used inside a building, meeting safety, insurance and government regulations
- Made with UL listed components
- Temperature range: 257°F (125°C) to -4°F (-20°C)



QuickLinks® Between Batteries

GA	Battery Volts	Center-to-Center	Negative	Positive
4	6	7"	205301	205302
	12	8-1/2"	205303	205304
2	6	7"	205311	205312
	12	8-1/2"	205313	205314

Input/Output Power Cables

GA	Center-to-Center	Negative	Positive
2	24"	205401	205402
	36"	205403	205404
	48"	205405	205406
1/0	24"	205411	205412
	36"	205413	205414
	48"	205415	205416

QuickLinks® 2/0 Cables and Jumpers ✓RoHS

- Made for truck, farm, construction, automotive and similar equipment
 - 2/0 GA fine-stranded copper conductor for maximum conductivity and flexibility
 - Meets or exceeds SAE and OEM specifications
 - Premium quality synthetic rubber insulated welding cable enables easy routing and cold weather flexibility
 - Connection sealed with MagnaTube™ heat-shrink
 - Temperature range: 221°F (105°C) to -58°F (-50°C)
- Welding Cable

QuickLinks® Between Batteries

Center to Center	Negative	Positive
8-1/2"	7625N	7626P
17"	7630N	7631P

For Stud Batteries - Battery to Ground Starter: Lug to Lug

Length	3/8" - 3/8" (10 mm - 10 mm)	3/8" - 1/2" (10 mm - 13 mm)
10"	7910F	7910H
15"	7915F	7915H
20"	7920F	7920H
25"	7925F	7925H
30"	7930F	7930H
35"	7935F	7935H
40"	7940F	7940H
45"	7945F	7945H

For Post Batteries - Battery to Ground Starter: Clamp to Lug

Length	Negative	Positive
10"	7910N	7910P
15"	7915N	7915P
20"	7920N	7920P
25"	7925N	7925P
30"	7930N	7930P
35"	7935N	7935P
40"	7940N	7940P
45"	7945N	7945P

Overmolded Group 31 Battery Assemblies

Overmolded Battery Assemblies

- Heavy duty cable assemblies harnesses for most multiple Group 31 battery applications
- Group 31 battery applications, up to 3/8" stud size
- Assemblies sizes for 2, 3 and 4 battery connections
- Available in black and red for polarity identification
- 2/0 GA PVC insulated battery cable with bare copper strand
- PVC overmold for corrosion and chemical resistance
- Connection points are tinned copper alloy
- Protective caps seal connections and are attached to the assemblies



NEW!

Size	Negative	Positive
2-Battery	9112	9122
3-Battery	9113	9123
4-Battery	9114	9124

Multi-Battery Assemblies

Battery Jumpers

- For Parallel Connection of 2 or 3 Batteries
- Exceeds SAE specifications
- Ideal for Group 27, Group 31 batteries and similar batteries
- Most efficient way to connect two or three paralleled batteries for delivery of maximum starting power at same voltage
- 2/0 gauge PVC-Insulated copper cable
- Steel inserts used for durability in 7751, 7502, 7701, 7580
- Temperature range: 221°F (105°C) to -58°F (-50°C)

Top Post-to-Power Take Off Post



Center-to-Center	Polarity	Part No.
6-13/16"	Negative	7751
	Positive	7752
7-3/8"	Negative	7753
	Positive	7754
14"	Negative	7755
	Positive	7756

Stud-to-Power Take Off Post



Center-to-Center	Polarity	Part No.
6-13/16"	Negative	7651
	Positive	7652
7-3/8"	Negative	7653
	Positive	7654
14"	Negative	7655
	Positive	7656

Stud-to-Power Take Off Stud



Center-to-Center	Polarity	Part No.
6-13/16"	Negative	7851
	Positive	7852
7-3/8"	Negative	7853
	Positive	7854
14"	Negative	7855
	Positive	7856

Three Battery Top Post-to-Power Take Off Post



Center-to-Center	Polarity	Part No.
13-5/8"	Negative	7701
	Positive	7702
14-3/4"	Negative	7703
	Positive	7704

Three Battery Stud-to-Power Take Off Post



Center-to-Center	Polarity	Part No.
13-5/8"	Negative	7601
	Positive	7602
14-3/4"	Negative	7603
	Positive	7604

Three Battery Stud-to-Power Take Off Stud



Center-to-Center	Polarity	Part No.
13-5/8"	Negative	7801
	Positive	7802
14-3/4"	Negative	7803
	Positive	7804

Lead Straight Jumpers



GA	Length	Lead
1	8"	7502
	10"	7504
	12"	7506
2/0	8"	7501
	10"	7503
	12"	7505

Offset Jumpers

- Designed for series connection of two batteries to achieve additive voltage
- Premium quality synthetic rubber insulated copper welding cable enables easy routing and cold weather flexibility
- Lead clamp permits square head bolt facing in or out for neat appearance and easier access

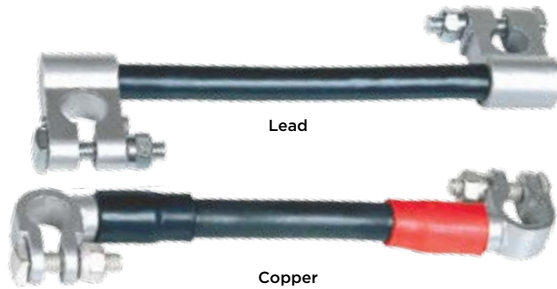

GA	Length	Lead	Copper
1	8"	7580	7780
	12"	7581	7781
	18"	7582	7782
	24"	7583	7783
2/0	8"	7586	7786
	12"	7587	7787
	18"	7588	7788
	24"	7589	7789

Aftermarket Pre-Made Automotive Cables

Light Duty Cars, Trucks, Vans, and RVs

- Meets or exceeds SAE specifications, ideal for OEM replacement
- Copper conductor for maximum conductivity
- Tinning of copper wire before casting ensures durable bond between wire and connector
- Antimonial lead connectors resist corrosion, die cast process seals copper wire from acid fumes and corrosive salts
- All have a standard 3/8" stud hole
- Standard Retail Cables
- Temperature range: 221°F (105°C) to -58°F (-50°C)

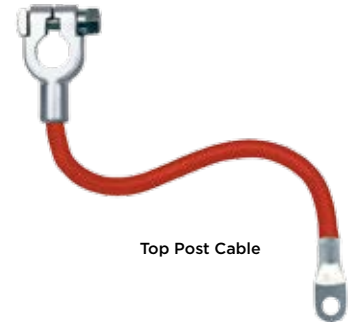

Top Post Cable

Top Post - Black Cables

Length	4 GA	1 GA
10"	7010	-
12"	7012	7112
15"	7015	7115
20"	7020	7120
24"	7024	7124
27"	7027	7127
30"	7030	7130
34"	7034	7134

Length	4 GA	1 GA
37"	7037	7137
42"	7042	7142
48"	7048	7148
52"	7052	7152
58"	7058	7158
65"	7065	7165
72"	7072	7172
78"	7078	7178

Top Post - Red Cables

Length	4 GA	1 GA
10"	8010	8110
12"	8012	8112
15"	8015	8115
20"	8020	8120
24"	8024	8124
27"	8027	8127
30"	8030	8130
34"	8034	8134

Length	4 GA	1 GA
37"	8037	8137
42"	8042	8142
48"	8048	8148
52"	8052	8152
58"	8058	8158
65"	8065	8165
72"	8072	8172
78"	8078	8178

Quick Replacement Ends

- Restore your original starting power
- Convenient for field service work near battery not under engine
- Ideal for mobile repair vans, tow trucks and other service vehicles
- Cuts inventory by reducing stock of slow moving longer cables, permits proper fitting repair parts to be available anytime
- Copper conductor for maximum conductivity
- Temperature range: 221°F (105°C) to -58°F (-50°C)



9603
Dual



9220P
Top Post

Automotive Tie Bolt Style

GA	Style	Part No.
8, 6 or 4	Top post, auxiliary lead	9606
	Side terminal, auxiliary lead	9510
	Top post, auxiliary lead, dual	9603
	Top post, lead-free, positive	9609P
	Top post, lead-free, negative	9609N

HD Compression Style

GA	Style	Part No.
2 & 1	Side terminal, universal	9511U
	Top post, positive	9220P
2/0	Top post, negative	9220N
	3/8" stud lug, universal	9222U

Side Terminal with Lead Wire - Black Cables

Length	4 GA
20"	7320
25"	7325
30"	7330
35"	7335
40"	7340

Length	4 GA
45"	7345
50"	7350
55"	7355
60"	7360
65"	

Switch to Starter - Black Cables

Length	4 GA	1 GA
10"	7410	7510
15"	7415	7515
20"	7420	7520
25"	7425	7525
30"	7430	7530

Length	4 GA	1 GA
35"	7435	7535
40"	7440	7540
45"	-	7545
50"	7450	7550
60"	7460	-

Side Terminal with Lead Wire - Red Cables

Length	4 GA
20"	8320
25"	8325
30"	8330
35"	8335
40"	8340

Length	4 GA
45"	8345
50"	8350
55"	8355
60"	8360
65"	8365

Switch to Starter - Red Cables

Length	4 GA	1 GA
10"	8410	8510
15"	8415	8515
20"	8420	8520
25"	8425	8525
30"	8430	8530

Length	4 GA	1 GA
35"	8435	8535
40"	8440	8540
45"	8445	8545
50"	8450	8550
55"	8455	8555



Side Terminal Cable with
Lead Wire



Switch to Starter
Cable

Quick Replacement Ends (Continued)

Cables with Lead Wires

- 4 GA, black, top post
- Has 12 GA auxiliary lead with butt connector



Length	Part No.
24"	730224
34"	730234
37"	730237
42"	730242
48"	730248
52"	730252
65"	730265
72"	730272

Top Post-to-Side Terminal Cables

- Converts top post to side terminal
- 4 GA cable is 7"
- Polarity specific, sold in pairs

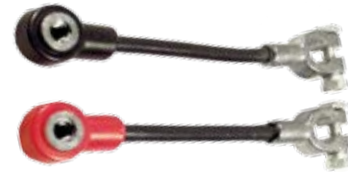

Description	Part No.
Top post to side terminal conversion	5505

Comes as a pair - 1 black & 1 red

Cup Jumpers/Formation Cables

- Used to charge batteries in series
- 10 GA UL 90°C wire (UL style 3046)
- Polarity-specific lead ends
- Custom jumpers available
- 16" (40 cm) long, center-to-center
- Fine-stranded copper conductor



Description	Part No.
10 GA 16" (40cm) cup jumpers	213910

Ford® Truck Positive Cable

- Fits Ford trucks with dual batteries
- Exceeds SAE electrical standards
- 2114 fits all Powerstroke engines
- Copper conductor for maximum conductivity
- Temperature range: 221°F (105°C) to -58°F (-50°C)

Length

GA	A	B	C	Part No.
2/0	62.5"	52.5"	22"	2114
	66.5"	56.5"	36"	2115
	56"	52"	39.5"	2116

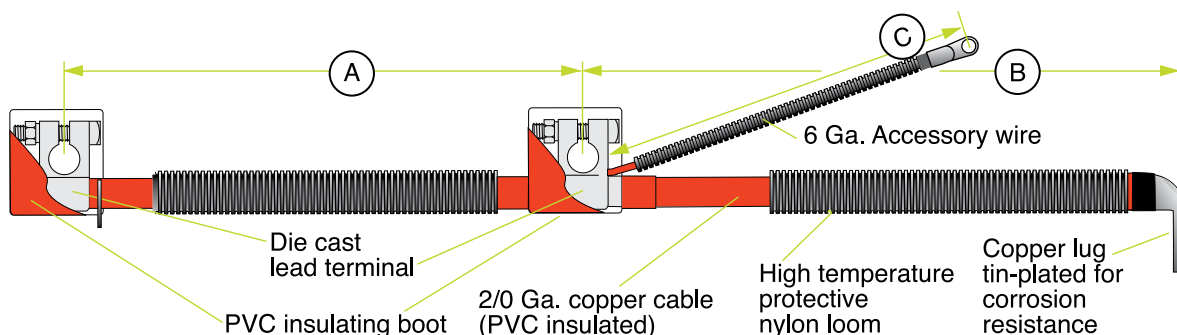

Golf Cart Cables

- Temperature range: 221°F (105°C) to -58°F (-50°C)

Best Series

4 Gauge Copper Cable with MAX™ Lugs & Heat Shrink

- These quality cables are 100% copper wire with copper, tin plated MAX® Lug connectors and heat-shrink protection
- Designed for extended use and maximum performance, these cables are ideal for custom cart builders, high performance and specialty carts



Length	Stud Hole
	5/16"
7"	205750
9"	205752
12"	205754
14"	205758
16"	205762
21"	205769
26"	205774

Better Series

6 Gauge Copper Cable with Zinc Plated Thimble

- These cables are quality OEM replacements featuring 100% copper wire for dependable operation
- Zinc plated thimble end resists corrosion
- High volume service shops don't have to compromise - these cables combine affordability and better materials to give you reliable long term performance
- Available 1 each, bags of 25 or bags of 100



Length	Stud Hole
	5/16"
7"	205700
9"	205702
12"	205704
14"	205708
16"	205712
21"	205719
26"	205724

Golf Cable Sets

- Now QuickCable offers pre-packaged sets of replacement cables for popular makes and models of golf carts, both gas and electric
- Easy to order and convenient for resale or your service department
- All cables are black, 6 gauge 100% copper with zinc plated thimble connectors

Quantity of Cables Per Golf Cart

Part No.	Length	205830 EZ Go RXV	205831 EZ Go Med/TXT	205832 EZ Go X444/ Marathon	205833 Club Car Precedent	205834 Club Car DS 48V Electric 95	205835 Club Car DS 36V Electric 81	205836 Yamaha Drive	205837 Yamaha G22	205838 Yamaha G19	205839 Yamaha G14/G16 36V Elec 94	205840 Yamaha G2/G8/G9 36V Elec 85-94
205700	7"	-	4	-	-	-	-	-	-	-	-	-
205702	9"	-	-	2	-	-	-	-	1	2	2	-
205704	12"	3	1	-	-	-	5	2	-	-	3	5
205708	14"	-	-	-	-	5	-	1	-	-	-	-
205712	16"	-	-	2	-	-	-	-	4	4	-	-
205719	21"	-	-	1	-	-	-	-	-	-	-	-
205724	26"	-	-	-	3	-	-	-	-	-	-	-



Primary Wire

- Available in 100ft and 1000ft spools
- We offer more sizes than listed! Contact us for more details



GPT General Purpose

- For use at 60V or less
- Meets or exceeds SAE J1128
- PVC insulation resists abrasion, fuel, oil, acid and salt
- Copper stranded conductor for maximum conductivity
- Temperature range: 176°F (80°C) to -40°F (-40°C)

GA	Black	Brown	Red	Orange	Yellow	Green	Blue	White
22	230000	230001	230002	230003	230004	230005	230006	230009
20	230100	230101	230102	230103	230104	230105	230106	230109
18	230200	230201	230202	230203	230204	230205	230206	230209
16	230300	230301	230302	230303	230304	230305	230306	230309
14	230400	230401	230402	230403	230404	230405	230406	230409
12	230500	230501	230502	230503	230504	230505	230506	230509
10	230600	230601	230602	230603	230604	230605	230606	230609
8	230700		230702	-	-	230705		230709

SXL Cross-Linked Polyethylene

- For use at 60V or less
- Meets or exceeds SAE J1128
- Designed for harsh, hot environments
- Copper stranded conductor for maximum conductivity
- Best resistance to abrasion, fuel, oil, acid and salt
- Temperature range: 257°F (125°C) to -60°F (-51°C)

GA	Black	Brown	Red	Orange	Yellow	Green	Blue	White	Gray
18	231200	231201	231202	231203	231204	231205	231206	231209	231210
16	231300	231301	231302	231303	231304	231305	231306	231309	231310
14	231400	231401	231402	231403	231404	231405	231406	231409	231410
12	231500	231501	231502	231503	231504	231505	231506	231509	231510
10	231600	231601	231602	231603	231604	231605	231606	231609	231610

MTW/TEW Wire

- Rated 600V
- UL and CSA 1015 listed
- Designed for wet or dry applications
- Copper stranded conductor for maximum conductivity
- Temperature range: 221°F (105°C) dry to 140°F (60°C) in oil

GA	Black	Brown	Red	Orange	Yellow	Green	Blue	White
18	236200	236201	236202	236203	236204	236205	236206	236209
16	236300	236301	236302	236303	236304	236305	236306	236309
14	236400	236401	236402	236403	236404	236405	236406	236409
12	236500	236501	236502	236503	236504	236505	236506	236509

UL® Marine Primary Wire

- Rated 600V
- UL 1426 listed
- Meets DOT and Coast Guard specifications for electrical systems
- Copper stranded conductor for maximum conductivity, tinned for corrosion resistance, gives extra protection in high corrosive marine applications
- Temperature range: 221°F (105°C) dry 167°F (75°C) wet

GA	Black	Brown	Red	Orange	Yellow	Green	Blue	White
16	251300	251301	251302	251303	251304	251305	251306	251309
14	251400	251401	251402	251403	251404	251405	251406	251409
12	251500	251501	251502	251503	251504	251505	251506	251509
10	251600	251601	251602	251603	251604	251605	251606	251609

Multi-Conductor Flat Jacketed

- For auto, truck, agriculture, construction and light marine applications
- Also known as Brake Cable
- For use at 60V or less
- Heavy duty flat PVC gray outer jacket is abrasion-resistant and protects against moisture, oil, acid and salt
- Meets or exceeds SAE J1128
- Copper stranded conductor for maximum conductivity
- Temperature range: 221°F (105°C) to -40°F (-40°C)



233201

2 Conductor

GA	Part No.	Colors	
16/2	233101	White	Black
14/2	233102		
12/2	233103		
10/2	233104		
8/2	233105		

3 Conductor

GA	Part No.	Colors		
16/3	233201	Green	White	Black
14/3	233202			
12/3	233203			
10/3	233204			

4 Conductor

GA	Part No.	Colors			
16/4	233301	Green	White	Black	Red
14/4	233302				
12/4	233303				
10/4	233304				

Jacketed Marine Wire

- Copper stranded conductor, tin plated for corrosion resistance
- Rated 600V
- Meets DOT specifications
- UL 1426 listed
- Temperature range: 221°F (105°C) dry to 167°F (75°C) wet



253101

2 Conductor

GA	Part No.	Colors	
16/2	253101	Black	White
14/2	253102		
12/2	253103		
10/2	253104		

3 Conductor

GA	Part No.	Colors		
16/3	253201	Green	White	Black
14/3	253202			
12/3	253203			
10/3	253204			

Parallel Bonded

- Designed for RVs and utility trailers
- Easily separated conductors are user friendly
- For use at 60V or less
- PVC insulation is abrasion-resistant and protects against moisture, oil, acid and salt
- Meets or exceeds SAE J1128
- Copper stranded conductor for maximum conductivity
- Temperature range 176°F (80°C) to -40°F (-40°C)



232101

2 Conductor

GA	Part No.	Colors	
16/2	232001	Black	Red
14/2	232002		

3 Conductor

GA	Part No.	Colors		
16/3	232101	Brown	Green	Yellow
14/3	232102			

4 Conductor

GA	Part No.	Colors			
18/4	232200				
16/4	232201	Brown	Green	White	Yellow
14/4	232202				

Control Cable

- For aerial and work platforms, forklift, trucks and other maintenance equipment
- Flexible insulation for easy routing and long, reliable life

TC Cable

- 600V, UL and CSA certified for indoor or outdoor use
- Small-diameter neoprene flexible TC type cable
- Arctic-grade neoprene, flame-retardant jacket, resistant to oil abrasion, sunlight, acids and alkaline
- Jute or nylon filter with mylar binder to reduce friction
- Fine-stranded copper conductor for maximum conductivity and flexibility
- Temperature range: 194°F (90°C) to -57°F (-55°C)



220104

5 Conductor

GA	Part No.	Colors				
18	220104	Black	Red	Blue	Orange	Yellow

8 Conductor

GA	Part No.	Colors				
18	220106	Black	Red	Blue	Orange	Yellow

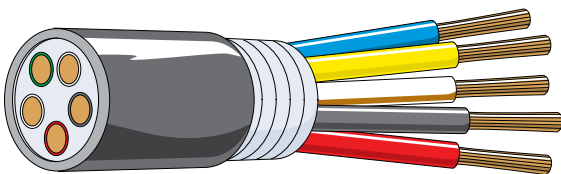

5 Conductor

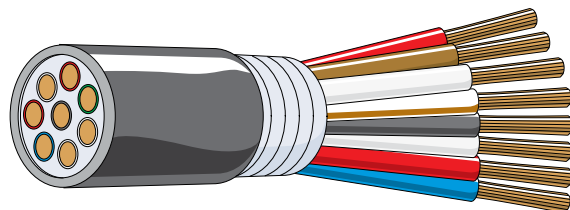

8 Conductor

SEOW Cable

- 600V, UL and CSA certified for indoor or outdoor use
- TPE jacketed
- Polypropylene filler with paper wrap
- Fine-stranded copper conductor for maximum conductivity and flexibility
- Temperature range: 221°F (105°C) to -40°F (-40°C)



220109

6 Conductor

GA	Part No.	Colors		
18	220109	Black	White	Red
		Green	Orange	Blue

Trailer Cable

Multi-Conductor

- For truck, bus, farm construction and commercial applications
- For use at 60V or less
- Fine-stranded copper conductor for maximum conductivity and flexibility
- Heavy duty PVC outer jacket protects against abrasion and resists moisture, oil and salt damage
- Meets or exceeds SAE J1128 and ATA specifications
- Junction blocks available
- Flexible for easy routing
- Temperature range: 176°F (80°C) to -67°F (-55°C)



234301

4 Conductor

GA/ Conductor	Part No.	Colors	
16/4	234101	Black	White
14/4	234102	Brown	Red

6 Conductor

GA/ Conductor	Part No.	Colors		
16/6	234201	Green	Black	White
14/6	234202	Red	Yellow	Brown

7 Conductor

GA/ Conductor	Part No.	Colors	
14/7	234301	Black	Blue
14/6, 12/1 (white)	234302	Brown	Green
14/4, 12/1 (blue)	234303	Red	White
10/2, (white, black)			
12/6, 10/1 (white)	234304	Yellow	

7 Conductor ABS Green Jacket

GA/ Conductor	Part No.	Colors		
12/4, 10/2, 8/1	234401	Black	Blue	
		Brown	Green	
		Red	White	
		Yellow		

Continuous Loop & Trunk Kits

- Rated 50V
- Color-coded flat wire terminates with one male and one female molded connector at each end
- Choice of 2, 3 or 4 pole styles
- Fine-stranded copper conductor for maximum conductivity and flexibility
- Temperature range: 176°F (80°C) to -40°F (-40°C)



Complete Trunk Kit

- Complete 4 pole trailer trunk kit
- Includes 3 inline splices, 3 butt splices and 2 ring terminals - nothing else required
- 60" continuous loop can be cut where needed

Continuous Loop Assemblies

Length	Description	No. of Poles	Gender	Part No.
12"	-	4	Male/Female	235101
24"	-			235105
60"	Trunk kit			235110
12"	-	2		235301
24"	-			235310
12"	-			235401
-	Protective caps	Fits 4 pole	Male	235901

Portable Cord

SJOOW Cord

- General purpose power supply cord for repair of power tools, battery chargers and other electrical equipment
- Flexible synthetic rubber outer jacket is oil, weather and sunlight-resistant
- Inner conductors are also oil-resistant
- 300V, UL and CSA certified for indoor or outdoor use
- Fine-stranded copper conductor for maximum conductivity and flexibility
- Temperature range: 194°F (90°C) to -40°F (-40°C)



270101

2 Conductor

GA	Part No.	Colors	
16/2	270103	White	Black
14/2	270104		
12/2	270107		

3 Conductor

GA	Part No.	Colors		
16/3	270101	Green	White	Black
14/3	270102			
12/3	270105			

SJO Cord

- Flexible synthetic rubber outer jacket is moisture, oil and weather resistant
- 300V, UL and CSA certified for indoor or outdoor use
- Temperature range: 194°F (90°C) to -40°F (-40°C)



220101

2 Conductor

GA	Part No.	Colors	
18/2	220102	White	Black

3 Conductor

GA	Part No.	Colors		
16/3	220101	Green	White	Black

Plugs - Male and Female

- Use with portable cord
- Three conductor
- 15 amp, 125 volt



Description	Part No.
Three prong female plug	507201
Three prong male plug	507211

Braided Ground Straps

- Fine-stranded copper conductor for maximum conductivity and flexibility
- Corrosion-resistant tin-plating ensures years of dependable service
- 1 and 25 piece quantities available

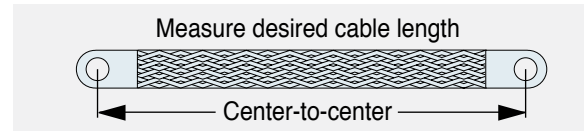

Contact Quick Cable for more information, quotations and lead times.

Custom Ground Strap Assemblies Also Available

- Make custom ground straps online at www.quickfigurator.com

Braided Ground Strap Chart

- This chart is a guide to help you determine the gauge of a braided ground strap. Lay your strap against these profiles. Care should be taken since braided straps of the same GA can vary in width and thickness.

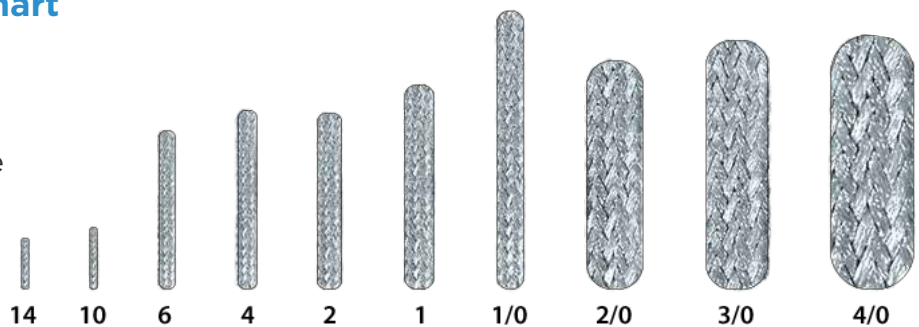

Pre-Made Lengths

- Available as 3/8" and 1/2" lug-to-lug as well as straight clamp-to-lug styles
- Packed in poly bags or retail packaging - bulk quantities also available
- Can custom build to your requirements
- Ability to use die cast lead connectors on 6 GA and 1 GA

GA	Length	Description	3/8" Hole	1/2" Hole
4	9"	Straight clamp-to-lug	7001	-
	13"	Straight clamp-to-lug	7003	-
	24"	Straight clamp-to-lug	7005	-
2	9"	Straight clamp-to-lug	7101	-
	13"	Straight clamp-to-lug	7103	-
	24"	Straight clamp-to-lug	7105	-
4	9"	Lug-to-lug	7401	7901
	13"	Lug-to-lug	7403	7903
	18"	Lug-to-lug	7404	-
	24"	Lug-to-lug	7405	7905



CABLE MANAGEMENT

- Heat-Shrink Tube 55-56
- Heat-Shrink Tube Kits.....56
- Terminal Protectors.....57-58
- OEM Style Caps.....59
- Split Loom 60
- Spiral Wrap.....60
- Expandable Sleeving 60
- Cable Ties 61-62
- Cable Tie Mounting Pad62
- Cable Clamps.....63
- Rubber Grommets63
- Tape 64



Heat-Shrink Tube

- Protects against corrosion
- Identifies positive and negative polarity
- Acts as strain relief and prevents abrasion
- Custom printing and lengths available



Private branding

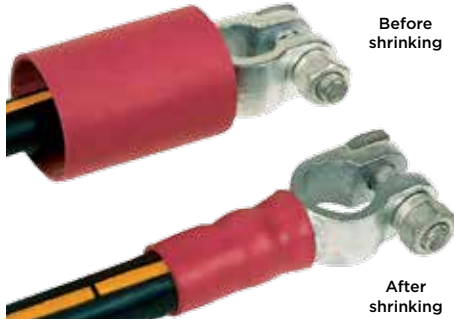

	MagnaTube™	SpliceTube™	FlexTube™	PrimaryTube™
Material	Polyolefin	Polyolefin	Polyolefin	Polyolefin
Shrink Ratio	3:1	4:1	3:1	2:1
Wall Thickness After Shrinking	1/8"	1/8"	1/16"	1/32"
Water Proof	Yes	Yes	Yes	No
Colors	Red & black	Clear & black	Red, black & clear	7 colors available
Adhesive Sealant	Yes	Yes	Yes	No
UL Listed	Yes #486D	No	No	Yes #224
Typical Use	Battery connectors – heavy duty	Battery connectors & primary wire – medium duty	Battery connectors & primary wire – medium duty	Primary wire
Operating Temperature	-55°C to +110°C -67°F to +230°F	-55°C to +125°C -67°F to +255°F	-55°C to +110°C -67°F to +230°F	-55°C to +135°C -67°F to +275°F

Expanded and shrunk diameters may vary 3-15%

MagnaTube™ Double Wall Heat-Shrink with Double Meltable Sealant

- 3:1 Shrink Ratio
- Premium quality for heavy-duty applications
- Class 1 and 2 specifications
- Conforms to DOD Mil-DTL-23053/15A
- Meets UL - 486D specifications
- Custom sizes and printing available



Expanded Diameter	Shrunk Diameter	Use With	Black	Red
3/8"	1/8"	8 - 6 GA	5611B	5612R
1/2"	3/16"	6 - 2 GA	5651B	5651R
3/4"	1/4"	4 - 2/0 GA	5613B	5614R
1-1/8"	3/8"	1/0 - 250 MCM	5615B	5616R
1-1/2"	1/2"	4/0 - 250 MCM	5617B	5618R
2"	5/8"	250 - 750 MCM	5619B	5619R

Blue Part Numbers = Flame-retardant

SpliceTube™ Twice the Meltable Sealant

- 4:1 Shrink Ratio
- Has the most sealant of any heat-shrink offered
- Great for multi-wire bundles
- Greater resistance to oil-based fluids



Expanded Diameter	Shrunk Diameter	Use With	Black	Clear
1/4"	1/16"	24 - 10 GA	506701	506711
5/16"	5/64"	18 - 8 GA	506702	506712
1/2"	3/32"	14 - 2 GA	506703	506713
3/4"	9/64"	1/0 - 2/0 GA	506704	506714

Blue Part Numbers = Flame-retardant

FlexTube™ Double Wall with Heat-Shrink with Meltable Sealant

- 3:1 Shrink Ratio
- Remains flexible after shrink
- Clear tube permits visual inspection for easy maintenance and trouble shooting



Expanded Diameter	Shrunk Diameter	Use With	Black	Red	Clear
1/8"	3/64"	24 - 18 GA	5657B	5657R	5657C
3/16"	1/16"	20 - 12 GA	5658B	5658R	5658C
1/4"	3/32"	18 - 10 GA	5659B	5659R	5659C
3/8"	1/8"	8 - 6 GA	5660B	5660R	5660C
1/2"	3/16"	6 - 2 GA	5661B	5661R	5661C
3/4"	1/4"	4 - 2/0 GA	5662B	5662R	5662C
1"	3/8"	2 - 4/0 GA	5663B	5663R	5663C
1-1/4"	7/16"	4/0 - 250 MCM	5672B	5672R	-

Blue Part Numbers = Flame-retardant

PrimaryTube™ Single Wall

- 2:1 Shrink Ratio
- Economical and ideal for general purpose applications
- Sealant free single wall construction
- Conforms to DOD Mil-I-23053/5 Class 1 and 2, also meets UL-224 125°C specification
- Colors available upon request - minimum quantities may apply



Expanded Diameter	Shrunk Diameter	Use With	Black	Red
3/32"	3/64"	24 - 16 GA	5664B	5664R
1/8"	1/16"	18 - 14 GA	5665B	5665R
3/16"	3/32"	14 - 10 GA	5666B	5666R
1/4"	1/8"	12 - 8 GA	5667B	5667R
3/8"	3/16"	10 - 6 GA	5668B	5668R
1/2"	1/4"	8 - 2 GA	5669B	5669R
3/4"	3/8"	1 - 2/0 GA	5670B	5670R
1"	1/2"	1/0 - 4/0 GA	5671B	5671R
1-1/2"	3/4"	4/0 - 250 MCM	5673B	5673R

Black Red White Green Blue Yellow Clear

Blue Part Numbers = Flame-retardant

Heat-Shrink Tube Kits

Tube Kits

- Dual wall inner surface lined with adhesive sealant which melts when heated: permanently seals connection as tube cools and shrinks
- SpliceTube shrinks 4:1 when heated
- Has the most sealant of any heat shrink tube offered
- Economical single wall heat-shrink tube ideal for general purpose applications

Description	Part No.
Double wall FlexTube black kit w/ adhesive	506390
Double wall FlexTube black & red kit w adhesive	506391
Single wall primary black kit	506590
Single wall primary assorted colors kit	506591
Triple wall SpliceTube black and clear kit w/ adhesive	506790

Blue Part Numbers = Flame-retardant



506391



506590



506591



506790

Terminal Protectors

- Reduces the risk of battery explosion cause by sparks
- High temperature PVC construction rated at +190°F (88°C)
- Conforms to SAE J1128 dielectric specifications - meets USCG requirements

Straight Clamps



Fits GA	Black	Red
6	5721B	5721R
4	5722B	5722R
1 & 2	5723B	5723R
1/0 & 2/0	5724B	5724R
3/0 & 4/0	5773B	5773R

Straight Clamps - Snap Fit



Fits GA	Black	Red
6 & 4	5704B	5704R
1 & 2	5702B	5702R

Straight or Angled Lug



Fits GA	Black	Red
4	5718B	5718R

Automotive Lug



Fits GA	Black	Red
1 & 2	5735B	5735R
1/0 & 2/0	5736B	5736R

Heavy Duty Starter



Fits GA	Inside Dimensions		Black	Red
	A	B		
4	11/31"	1-7/32"	5720B	5720R
1 & 2	1/2"	1-7/32"	5734B	5734R
1/0 & 2/0	19/32"	1-9/16"	5737B	5737R
3/0	5/8"	1-9/16"	5775B	5775R

Medium Duty Starter



Fits GA	Black	Red
4 & 6	5719B	5719R

Elbow Terminals



Fits GA	Right		Left	
	Black	Red	Black	Red
1 & 2	5729B	5729R	5727B	5727R
1/0 - 3/0	5730B	5730R	5728B	5728R
4/0	5779B	5779R	5778B	5778R

Snap-On Insulator



Description	Part No.
10-8 snap-on red	5738R
10-8 snap-on blk.	5738B

Terminal Protectors (Continued)

- Reduces the risk of battery explosion cause by sparks
- High temperature PVC construction rated at +190°F (88°C)
- Conforms to SAE J1128 dielectric specifications - meets USCG requirements

Garden Tractor and L Terminal



Fits GA	Elbow Style	Black	Red
8, 6, 4	Right elbow	5709B	5709R
8, 6, 4	Left elbow	5710B	5710R

Dual-Post Insulator

- Attach with cable ties
- UL94 V-2 rated and RoHS compliant



Fits GA	Black	Red
1/0 gauge maximum	5712B	5712R
4/0 gauge maximum	5713B	5713R

Flag Clamps



Fits GA	Black	Red
1 & 2	5725B	5725R
1/0 & 2/0	5726B	5726R
2/0 & 3/0	5774B	5774R
4/0	5777B	5777R

Military Style



Black	Red
5707B	5707R

Side Terminal Cover



Fits GA	Black	Red
8 - 1	5711B	5711R

Tab Insulator



Fits GA	Terminal O.D.	Black	Red
8 - 2	.73"	5741B	5741R
	.87"	5743B	5743R
2 - 2/0	1.03"	5745B	5745R
	1.20"	5747B	5747R
3/0 - 4/0	1.37"	5749B	5749R

Marine Terminal - Fixed



Fits GA	Black	Red
1 & 2	5732B	5732R
1/0 & 2/0	5733B	5733R

Marine Terminal - Swivel



Fits GA	Black	Red
Various gauges, single or multiple cables.	5705B	5705R

OEM Style Caps

- Reduces the risk of battery explosion cause by sparks
- High temperature PVC construction rated at +190°F (88°C)
- Conforms to SAE J1128 dielectric specifications - meets USCG requirements

Lead Free Terminal Protector



Fits GA	Black	Red
6 - 8	501101	501102
4 - 1	501103	501104

Top Post Rigid Battery Cap



Black	Red
501010	501011

Side Post Rigid Battery Cap



Black	Red
501020	501021

Lawn and Garden Post Cap



Black	Red
501030	501031

Heavy Duty Type-T and Group 31-T



Black	Red
501040	501041

Nylon Marine Cap



5/16"	3/8"
Black	Red
501060	501061

Connection Point Insulator



Red
509688



Split Loom

- Shield wire, cable and hose from heat, shorts and corrosion
- Black nylon, 6" constructions meets or exceeds SAE standards
- Convuluted design stays flexible at all temperatures for easy routing
- Flame retardant, polypropylene, split loom
- Meets UL-94V2 rating



Nylon Split Loom -40°F to +300°F (-40°C to +149°C)

Inner Diameter Size	Part No.
1/4"	505101
3/8"	505102
1/2"	505103
5/8"	505104
3/4"	505105
1"	505106
1-1/4"	505107
2"	505110

Polyethylene Split Loom -40°F to +200°F (-40°C to +93°C)

Inner Diameter Size	Part No.
1/4"	505201
3/8"	505202
1/2"	505203
5/8"	505207
3/4"	505204
1"	505205
1-1/4"	505206
1-1/2"	505208
2"	505210

Spiral Wrap

- Spiral protective sheathing wraps on like tape
- Allows flexible routing and breakouts
- Prevents kinking and curling of wires
- Insulates cables, absorbs vibration and protects wires



-40°F to +200°F (-40°C to +93°C)

O.D. Size	Black	Natural
1/8"	503151	503251
1/4"	503152	503252
3/8"	503153	503253
1/2"	503154	503254
3/4"	503155	503255
1"	503156	503256

Expandable Sleeving

- Fray-resistant, cuts with scissors
- High abrasion-resistant polyethylene
- Increased braid density for better coverage



Melt Temp 446°F (+230°C)

Nominal Size	Expansion Range		Part No.
	Minimum	Maximum	
1/4"	5/32"	7/16"	505301
3/8"	3/16"	5/8"	505302
1/2"	1/4"	3/4"	505303
3/4"	5/8"	1"	505304
1-1/4"	1"	1-1/2"	505306

Cable Ties

- Temp range -40°F to +185°F (-40°C to +85°C)
- Black ties are UV-stabilized for long life
- 6/6 nylon provides superior strength
- Factory sealed bags to ensure product longevity

Cable Management

Standard Cable Ties



Length	Tensile Strength	Maximum Bundle Dia.	Width	Natural	UV Black
7.5" (191 mm)	50 lb. (22.7 kg.)	1-3/4" (44 mm)	.180" (4.57 mm)	502110	502210
11.1" (282 mm)		3" (76 mm)		502111	502211
14.1" (358 mm)		4" (102 mm)		502112	502212

Push Mount Cable Ties



Length	Tensile Strength	Maximum Bundle Dia.	Width	UV Black
7.5" (191 mm)	50 lb. (22.7 kg.)	1-3/4" (44 mm)	.189" (4.80 mm)	502246

Miniature and Intermediate Cable Ties



Length	Tensile Strength	Maximum Bundle Dia.	Width	Natural	UV Black
4.0" (102 mm)	18 lb. (8.2 kg.)	7/8" (22 mm)	.095" (2.41 mm)	502101	502201
8.0" (203 mm)		2" (51 mm)		502102	502202
5.6" (142 mm)	30 lb. (13.6 kg.)	1-1/4" (32 mm)	.140" (3.55 mm)	502103	502203
8.5" (216 mm)	40 lb. (18.2 kg.)	2" (51 mm)		502104	502204

Releasable Cable Ties



Description	Width	Natural	UV Black
7.5" / 50 lb. low profile cable tie	.299" (7.60 mm)	502155	502255

Mounting Hole Cable Ties



Length	Tensile Strength	Maximum Bundle Dia.	Width	Natural	UV Black
6.0" (152 mm)	30 lb. (13.6 kg.)	1-1/4" (32 mm)	.138" (3.50 mm)	502141	502241
7.5" (191 mm)	50 lb. (22.7 kg.)	1-3/4" (44 mm)	.177" (4.49 mm)	502142	502242
11.1" (282 mm)		3" (76 mm)		502143	502243
14.5" (368 mm)		4" (102 mm)		502144	502244
14.8" (376 mm)	120 lb. (54.4 kg.)	4" (102 mm)	.298" (7.56 mm)	502145	502245

Low Profile Cable Ties



Description	Width	UV Black
7.5" / 50 lb. low profile cable tie	.177" (4.49 mm)	502250

Heavy Duty Cable Ties



Length	Tensile Strength	Maximum Bundle Dia.	Width	Natural	UV Black
8.0" (203 mm)	120 lb. (54.4 kg.)	2" (51 mm)	.300" (7.62 mm)	502121	502221
14.25" (362 mm)		4" (102 mm)		502122	502222
18.0" (457 mm)		4-7/8" (124 mm)	.302" (7.67 mm)	502123	502223
28.0" (711 mm)		8" (203 mm)	.295" (7.52 mm)	502124	502224

I.D. Cable Ties



Length	Tensile Strength	Maximum Bundle Dia.	Width	Natural
7" (178 mm)	50 lb. (22.7 kg.)	1-3/4" (44 mm)	.181" (4.59 mm)	502113

Metal Table Premium 6/6 Cable Ties



Length	Tensile Strength	Width	Natural	UV Black
4" (102 mm)	18 lb. (8.1 kg.)	.091" (2.29 mm)	502301	502401
5.5" (140 mm)	30 lb. (18.1)	.14" (3.56 mm)	502305	502405
7.5" (191 mm)	50 lb. (22.6)	.185" (4.699 mm)	502309	502409
11.5" (292 mm)		.187" (4.74 mm)	502310	502410
13" (330 mm)	120 lb. (54.4)	.27" (6.86)	502311	502413
14" (356 mm)	50 lb. (22.6)	.187" (4.74 mm)	502313	502411

Extra Heavy Duty Cable Ties



Length	Tensile Strength	Maximum Bundle Dia.	Width	Natural	UV Black
24.0" (610 mm)	175 lb. (79.3 kg.)	7.2" (180 mm)	.340" (8.63 mm)	502131	502231
36.0" (914 mm)		10.7" (272 mm)		502132	502232
41.0" (1041 mm)		12" (305 mm)		502133	502233
48.0" (1219 mm)		15" (389 mm)		502134	502234

Cold Weather Cable Ties

- Flexibility and strength in cold weather environments
- Material rated to withstand -40°F (-40°C) per ISO 180



Description	Quantity	UV Black
7.56" length – 50 lb.	100	502280
11.25" length – 50 lb.		502281
14.25" length – 50 lb.		502282
15.09" length – 120 lb.		502283

Acid-Resistant Cable Ties

- Acid-resistant polypropylene won't become brittle when in contact with battery acid or fumes (sulfuric acid)



Length	Tensile Strength	Maximum Bundle Dia.	Width	Natural	UV Black
7.5" (191 mm)	50 lb. (22.7 kg.)	2" (51 mm)	.190" (4.83 mm)	502160	502260
14" (356 mm)	30 lb. (13.6 kg.)	3-1/2" (89 mm)	.180" (4.57 mm)	-	502261

Fluorescent Cable Ties

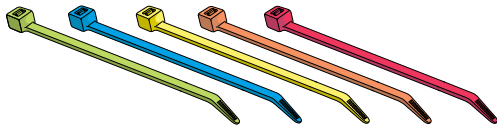

Length	Tensile Strength	Maximum Bundle Dia.	Width	Color	Part No.
8.5" (216 mm)	40 lb. (18.2 kg.)	2" (51 mm)	.140" (3.55 mm)	Blue	502205
				Green	502206
				Orange	502207
				Pink	502208
				Yellow	502209

Cable Tie Mounting Pad

- Flush-mount self-adhesive nylon pads for use with 18-50 lb cable ties
- Countersunk for #6 screw mount



Length	Color	Part No.
3/4" x 3/4"	UV Black	502601
	Natural	502621
1" x 1"	UV Black	502602
	Natural	502622

Cable Clamps

Nylon Cable Clamps

- Flexible design conforms to cable contour
- Mounting holes accept #10 size hardware
- Non-conductive, non-corrosive, resists fuel and chemicals

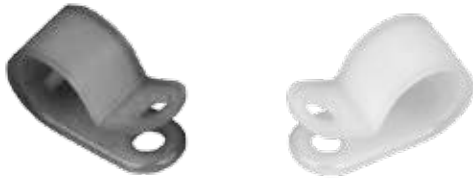

Description	Diameter	Black		Natural	
		Width 3/8"	Width 1/2"	Width 3/8"	Width 1/2"
Nylon cable clamp	3/16"	504611	–	504621	–
	1/4"	504612	–	504622	–
	5/16"	504613	–	504623	–
	3/8"	504614	–	504624	–
	1/2"	504615	–	504625	–
	5/8"	–	504631	–	504641
	3/4"	–	504632	–	504642
	1"	–	504633	–	504643

EPDM Steel Covered Clamps

- Flexible EPMD cushion holds firmly and protects from shock
- Zinc-electroplated for extra corrosion resistance
- 3/8" mounting hole for 1/2" width
- 1/2" mounting hole for 5/8" width



Description	Diameter	Width 1/2"	Width 5/8"
EPDM clamp	1/4"	504401	504501
	3/8"	504402	504502
	1/2"	504403	504503
	5/8"	504404	504504
	3/4"	504405	504505
	7/8"	504406	504506
	1"	504407	504507
	1-1/8"	504408	504508
	1-1/4"	504409	504509
2"	–	504511	

EPDM Stainless Steel Covered Clamps

- Flexible EPMD cushion holds firmly and protects from shock
- Stainless steel won't rust
- 1/4" mounting hole



Description	Diameter	Width 1/2"
EPDM stainless steel clamp	1/4"	504421
	3/8"	504422
	1/2"	504423
	5/8"	504424
	3/4"	504425
	1"	504427
	1-1/4"	504429
	1-1/2"	504431

Rubber Grommets

- Allows wire to pass through drill holes without damage to insulation
- Slotted sides enable snap in installations



Description	Part No.
Rubber grommet, 5/16" O.D. x 3/16" I.D.	120123
Rubber grommet, 3/8" O.D. x 1/4" I.D.	120124
Rubber grommet, 1/2" O.D. x 3/8" I.D.	120125
Rubber grommet, 1/4" O.D. x 1/8" I.D.	120126

Tape

PVC Electrical Tape

- UL and CSA listed
- Flame-retardant and cold-resistant



Roll Length	Color	Part No.
60 Feet	Black	507101

Silicone Tape

- Unlimited uses, wire harnesses, terminal ends, emergency repairs.
- Black silicone tape, UV/chemical resistant
- Won't melt up to +500°F (+260°C)
- Tensile strength 700 PSI insulates to 8000 volts
- Self-bonding, permanent
- Meets specifications for U150



Roll Length	Color	Part No.
10 Feet	Black	507110



Notes:

MATERIAL HANDLING

- SB® Connector Contacts.....67
- Fusion SB® Solder Contacts.....67
- SB® Connector Housings67
- SB® Connector Kits68
- Weatherproof SB® Style Connector.....68
- PowerPole Contacts & Housings.....68
- PowerPole Kits69
- SBX® Battery Connectors69
- SBX Kits.....69
- SB®/SBX®/DIN Accessories 70-71
- Safety Boots.....72
- EBC/DIN Battery Connector Kits.....72-73
- Intercell Connectors.....73-74
- Leadhead Shrouds.....75
- Leadhead Cones & Thimbles.....76
- Pre-Made Cables77
- Leadheads - Standard Bore77-78
- Leadheads - Universal.....79
- Leadheads - Fast Charge.....79
- Post Mold.....80
- Leadhead Drill80
- Carbon Arcing Cable Assembly80



SB® Connector Contacts Original

SB® Crimp Contacts

- Silver plated solid copper contact
- Excellent for general commercial and industrial applications

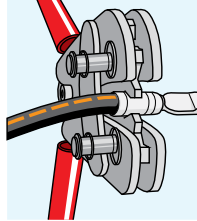
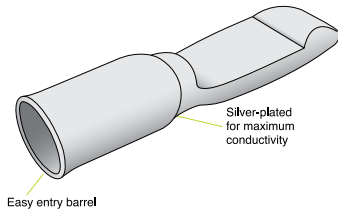

GA	Amp	Part No.
10/12	50	123101
8	75	123131
6	50	123103
6	120	123142
4	120	123143
2	120	123144
4	175	123104
2	175	123105
1/0	175	123107
1/0	350	123401
2/0	350	123108
3/0	350	123109
4/0	350	123110

Material Handling

Fusion® SB® Solder Contacts

- Silver plated solid copper contact
- Especially good in presence of destructive vibration or corrosive chemicals
- Visit www.QuickHowTo.com to learn more about our Fusion® line!
- Pullout strength better than any crimp method (see chart on page 15)
- Contacts come with pre-loaded flux and solder
- Contacts come ready to use, just add heat, no crimp tool necessary
- Fast and convenient
- Patented

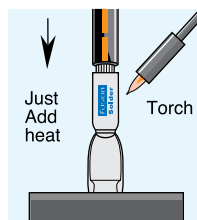
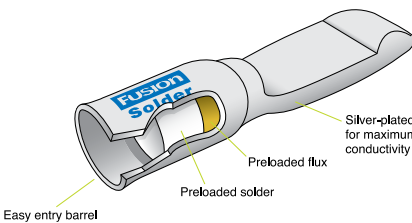

GA	Amp	Part No.
4 & 2	175	121105
1/0	175	121107
2/0	350	121108
3/0	350	121109
4/0	350	121110

SB® Connector Housings

- Housings are color-keyed
- Gray housings will only plug into gray housings, not red or blue housings
- The color key feature makes it possible for you to differentiate voltages of your electrical circuits



Voltage color code guideline

Housing	Voltage
Red	24V
Gray	36V
Blue	48V
Yellow	12V
Orange	18V
Green	72V

Amp	GA	Gray	Red	Blue
50	10/12	122101	122201	122301
	8			
	6			
120	6	122109	122209	122309
	4			
	2			
175	4	122104	122204	122304
	2			
	1/0			
350	2/0	122108	122208	122308
	3/0			
	4/0			

*SB®, SBX® and PowerPower® Connectors is a registered trademark of Anderson Power Products, Inc.

Other colors available

SB® Connector Kits

- Kits includes 2 contacts and 1 housing
- Smaller pack quantities



Crimp kit
(1 housing and 2 contacts)



Fusion kit
(1 housing and 2 contacts)

Crimp Kit (1 housing, 2 contacts)

Amp	GA	Gray	Red	Blue
50	10/12	124101	124201	–
	6	124103	124203	–
120	6	124121	124221	124321
	4	124122	124222	124322
	2	124123	124223	124323
175	4	124104	124204	124304
	2	124105	124205	124305
	1/0	124107	124207	124307
350	2/0	124108	124208	124308
	3/0	124109	124209	124309
	4/0	124110	124210	124310

Fusion® Kit (1 housing, 2 contacts)

Amp	GA	Gray	Red
175	4 & 2	125105	125205
	1/0	125107	125207
350	2/0	125108	125208
	3/0	125109	125209
	4/0	125110	125210

Material Handling

Weatherproof 300 Amp SB® Style Connector

- Ideal for outdoor environments.
- Uses standard 350 amp contacts; male and female parts are required
- 301300 male connector kit includes housing, seals, contacts not included; blue
- 301302 female connector kit includes housing, seals; contacts not included; blue



Description	Part No.
Male, 300 amp weatherproof	301300
Female, 300 amp weatherproof	301302

PowerPole® Contacts & Housings®

- Single pole contact housing
- Housings lock together to create custom solutions
- Silver plated solid copper contact

Housings



Color	30 Amps	75 Amps	120 Amps	180 Amps
Red	122270	122271	122272	122273
Blue	122370	122371	122372	122373
Black	122470	122471	122472	122473

Contacts (Crimp)



Amps	GA	Part No.	Amps	GA	Part No.
30	12/16	123115	120	4	123143
	10/12	123130		2	123144
75	8	123131	180	4	123153
		123132		2	123154
120	6	123142	1/0	123156	

*SB®, SBX® and PowerPower® Connectors is a registered trademark of Anderson Power Products, Inc.

PowerPole® Kits

Kits (1 Housing, 1 Contact)

- Single pole contact housing
- Housings lock together to create custom solutions
- Silver plated solid copper contact



Color	16/12 GA 30 Amp	2 GA 120 Amp	1/0 GA 180 Amp
Red	124270	124272	124273
Blue	124370	124372	124373
Black	124470	124472	124473

SBX® Battery Connectors

- SBX® connectors are similar to SB® connectors, but feature two additional smaller auxiliary contacts for secondary circuit connection

SBX® Contacts

- Available in 175 and 350 amp ratings
- Solid copper contacts



GA	Amps	Part No.
2	175	123205
1/0	175	123207
2/0	350	123208
3/0	350	123209
4/0	350	123210

SBX® Housings

- Housings available in four colors
- Available in 175 and 350 amp ratings



GA	Amps	Gray	Red	Blue	Yellow
2, 4, 1/0	175	122504	122604	122704	122804
2/0, 3/0, 4/0	350	122508	122608	122708	122808

SBX® Kits

- Kit includes 2 contacts, 1 housing, 2 auxiliaries with securing pins, 2 cable ties for cable management

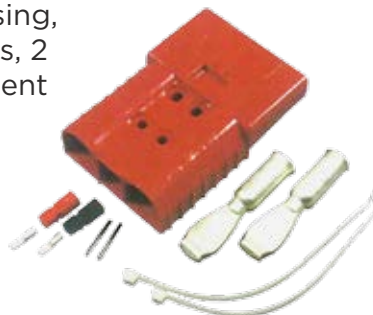

GA	Amps	Gray	Red	Blue	Yellow
1/0	175	124507	124607	124707	124807
2/0	350	124508	124608	124708	124808
3/0		124509	124609	124709	124809
4/0		124510	124610	124710	124810

SBX® Auxiliary Kits

Description	Part No.
*SBX 175 amp contact replacement kit	123001
*SBX 350 amp contact replacement kit	123002

*SB®, SBX® and PowerPower® Connectors is a registered trademark of Anderson Power Products, Inc.

SB®/SBX®/DIN Accessories

SB® & SBX® Manual Releases

- Extra strong, epoxy coated, steel structure; smooth procedure for connecting and disconnecting *SB housings; maintains correct alignment for connectors; attach using supplied hardware

SB® Manual Releases



Locking Half	Contains	Part No.
175 amps	Locking half, cable clamp, lockout spring, 3 machine screws, nuts and lockwashers	126201
350 amps		126203
Mounting Half	Contains	Part No.
175 amps	Mounting half, 2 machine screws, nuts and lockwashers	126202
350 amps		126204

SBX® Manual Releases

Locking Half	Contains	Part No.
175 amps	Locking half, cable clamp, lockout spring, 3 machine screws, nuts and lockwashers	126211
350 amps		126213
Mounting Half	Contains	Part No.
175 amps	Mounting half, 2 machine screws, nuts and lockwashers	126212
350 amps		126214

Material Handling

T Handle



Amps	Part No.
50	126101

A-Frame Handles



Amps	Part No.
175	126102
350	126103

SB® Handle

- Coated steel



Amps	Part No.
350	126107

DIN Manual Release

- Use with DIN connectors



Amps	Contains	Part No.
320	Manual release bracket	127203
	Manual release lever	127204

Cable Clamps

- Used with all SB®, SBX® and DIN



Amps	Part No.
50	126301
175	126302
175	126305*
350	126303

SB® Extraction Tool



Amps	Part No.
175	126900
350	126901

Safety Lockout



Safety Lockout
(Lock not included)

Amps	Part No.
175	126205
350	126206

*SB®, SBX® and PowerPower® Connectors is a registered trademark of Anderson Power Products, Inc.

SB® Lock Box

- Made of durable polypropylene
- Fits SB, SBX and DIN connectors
- Fits 50-, 175- and 350-amp connectors
- Has two padlock positions for OSHA lock-out/tag-out programs
- Lock-out the charger, truck and battery
- Lock together to complete charging cycle, battery cool down, proper battery rotation, etc.
- Patent pending



Safety Lockout
(Lock not included)

Description	Part No.
SB lock box	126207

*SB® and SBX® Connectors is a registered trademark of Anderson Power Products, Inc.

Cable Tower

- Used with all *SB®, SBX® and DIN
- Designed for industrial battery and charger cables
- Longer cable life
- Less damage to connector plugs
- Safer working conditions



127602
hanger
bracket



127601
3-hole
replacement
clamp (fits up to
3/0 cable)



127603
cable tower
mounting bracket



Unique
non-
conductive
cable clamp
included with
each cable
tower



40" steel pole, clear zinc dichromate plated to prevent corrosion

Steel enclosure for safety, no pinch points

Internal 8" heavy duty spring allows pole to tip and return to upright position

7/16" aircraft quality mounting bolt, split washer and nut

Description	Part No.
Tower and 3-hole clamp	127600
3-hole replacement clamp	127601
Hanger bracket	127602
Cable tower mounting bracket	127603



Safety Boots

- The first step to keeping the terminals clean when equipment is disconnected
- Safety boots are a QuickCable innovation and unique product
- Boots can be customized to fit exactly by cutting the opening to fit the cables being used
- Protect connectors from impact damage, provide strain relief for the cables, help prevent accidental arcing, seal out acid, dirt and moisture, and fit all major brands of connectors
- Custom printing available on boots and caps



126411



126421



126401

SB, SBX* and PowerPower* Connectors is a registered trademark of Anderson Power Products, Inc.

Quick®/SB®/SBX® Safety Boots

Amps	Gauge Range	Part No.	Connector Type
50	12 - 6	126411	*SB®
175	4 - 1/0	126412	
350	2/0 - 4/0	126413	
175	4 - 1/0	126416	*SBX®
350	2/0 - 4/0	126417	

Quick®/SB® Protective Kit (Boot & Cap)

Amps	Gauge Range	Part No.
50	12 - 6	126421
175	4 - 1/0	126422
350	2/0 - 4/0	126423

Protective Caps

Amps	Part No.
50	126401
175	126402
350	126403

Material Handling

EBC/DIN Battery Connector Kits

- DIN connectors conform to specification DIN43589-1 except the cable barrel fits American Wire Gauge (AWG) cable instead of metric wire
- Ideal for North American fast charging systems because DIN connectors have greater current carrying capacity compared with standard connectors
- Two large round contacts, up to four auxiliary contacts can be used for battery monitoring and charger applications
- Kits include connectors, housing and auxiliaries (two 14/18 upper and two 14/18 lower auxiliaries)
- Hexagon voltage key for 24-, 36-, 48-, 72-, 80- and 96- volt systems
- Handle available separately

Male 320 DIN Connector Kits



GA	Amp	Part No.
1/0	320 w/aux. tips	127517
2/0		127518
3/0		127519
4/0		127520

Female 320 DIN Connector Kits



GA	Amp	Part No.
1/0	320 w/aux. tips	127507
2/0		127508
3/0		127509
4/0		127510

EBC/DIN Battery Connector Kits (Continued)

Male 160 Amp Connector Kit



GA	Amp	Description	Part No.
4	160	No Handle	127514
2		No handle & 4 auxiliary tips	127515
1/0			127516

Female 160 Amp Connector Kit



GA	Amp	Description	Part No.
4	160	With handle	127504
2		With handle & 4 auxiliary tips	127505
1/0			127506

DIN Handle Kit



Amps	Description	Part No.
320	Two piece handle kit	127205

Intercell Connectors

- Safe-burning, high-conductivity lead QuickLink intercell connectors
- Available in two thicknesses: High Capacity Intercells, same thickness as standard, and Ultra Capacity Intercells, which are double the thickness of our High Capacity
- Center-to-center size molded into each intercell
- 3% antimonial lead, free of voids and porosity, greater electrical conductivity
- Ultra Capacity Intercells have thicker strap and burn rings ideal for “fast charge” batteries
- Shrouds fit easily

QuickLink®

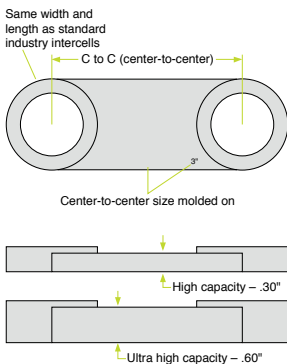

QuickLink® High Capacity	
C-to-C	Part No.
3"	215020
3-1/8"	215021
3-1/2"	215023
3-3/4"	215025
5"	215040
5-3/4"	215045
6"	215048

QuickLink® Ultra	
C-to-C	Part No.
3"	215120
3-1/8"	215121

Intercell Shroud: Black



2-Hole pictured
3-Hole & 4-Hole available

Color	Fits Intercell Size	I.D.	Part No.
Black	3" to 3-1/8" C-C	4.59"	215819B
	3-1/2" C-C	5.13"	215820B
	3-3/4" C-C	5.19"	215823B
	5" C-C	6.56"	215824B
	10-1/2" to 10-3/4" C-C	12.25"	215821B
	12-1/2" to 12-3/4" C-C	14.19"	215822B

Lead Stick Burn Bar

- Made of 5% antimonial lead
- Clean melting alloy, free of foreign material, voids and porosity
- Sticks are 12" long (30.5cm.) and weighs 1 pound (.45 kg.)



Description	Part No.
12" - 1 lb. lead stick	2599

Intercell Shroud: Blue



Color	Fits Intercell Size	I.D.	Part No.
Blue	3" to 3-1/8" C-C	4.59"	215825
	3-1/2" to 3-3/4" C-C	5.26"	215826

For use with universal leadhead

8D Bolt on Bus Bar Terminals

- 3/8" positive and 3/8" negative
- used to convert top post 8D batteries to side terminal for marine and heavy truck use
- Die cast lead with steel insert; packaged in bulk



Description	Polarity	Part No.
Bus bar terminal	Negative	6995
	Positive	6994

Small Bore "L" Terminal

- 3/4" post hole (.75", 19mm)
- Converts SAE post to "L" terminal
- Used to adapt batteries for use in floor scrubbers and golf carts



Description	Part No.
L term., 1/4" & 5/16" (6 & 8 mm)	214960
L term., 3/8" (10 mm)	214961



Leadhead Shrouds

- Protects system from electrical shorts between battery cells
- Reduces the risk of battery explosion caused by sparks
- High-temperature MDPE construction
- Color-coded for easy polarity identification
- Meets OSHA and USCG requirements

Material Handling

Offset 2-Hole



3.75" Center-to-Center 3.0" Center-to-Center

Color	Side	Part No.	Color	Side	Part No.
Black	Right	215800B	Black	Right	215804B
	Left	215802B		Left	215806B
Red	Right	215801R	Red	Right	215805R
	Left	215803R		Left	215807R

Offset 3-Hole



3" - 3.75"

Color	Side	Part No.
Black	Right	215830B
	Left	215832B
Red	Right	215831R
	Left	215833R

Fast Charge

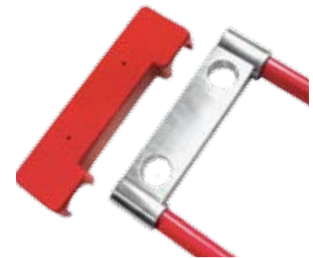

Color	Part No.
Black	215850B
Red	215851R

Offset



Color	Side	Part No.
Black	Right	215815B
	Left	215817B
Red	Right	215816R
	Left	215818R

Straight



Color	Part No.
Black	215846B
Red	215847R

Universal



Color	Part No.
Black	215840B

Leadhead Cones and Thimbles

- Cones fit all gauge sizes
- Available in 1, 2 and 3 hole designs
- Post hole 15/16" (.937", 24mm)
- Fits all major brands of thimbles



1 hole cone



2 hole cone



3 hole cone

Maintenance-Free Cones

- 5% antimonial lead for durability with tin plated copper reinforcing sleeve molded into cone.
- Eliminates the need for periodic tightening of the thimble

Style	Center to Center	Part No.
1 hole	–	214931
2 hole	3"	214932
2 hole	3-3/4"	214933
3 hole	3-3/4"	214934

Standard Cones

- 5% antimonial lead

Style	Center to Center	Part No.
1 hole	–	214921
2 hole	3"	214922
2 hole	3-3/4"	214923
3 hole	3-3/4"	214924

Material Handling

Crimp or Solder Thimble

- 100% copper alloy tin-plated for corrosion resistance
- Crimp with HexCrimp tool or solderable
- Fasteners sold separately
- Color-coded to match cable gauge
- Barrel accepts two crimps



GA	Part No.
2	214901
1	214903
1/0	214905
2/0	214907
3/0	214909
4/0	214911

Fusion[®] Solder Thimble

- 100% copper alloy tin-plated for corrosion resistance plus preloaded flux and solder
- Perfect Solder connection every time, fast and convenient
- Fits all brands of cones
- Thimble ready to use "Just add Heat"
- Gauge printed on barrel
- Patented
- Visit www.QuickHowTo.com to learn more about our Fusion[®] line!



GA	Fusion
2	214902
1	214904
1/0.	214906
2/0.	214908
3/0	214910
4/0	214912

Cone/Thimble Fasteners



106101



106102



106103

Description	Part No.
Stainless steel bolt	106101
Stainless steel flat washer	106102
Stainless steel lock washer	106103
Fastener kit (10 of each)	106104

Pre-Made Cables

- 10 foot cable with thimble at each end
- Red cable for positive
- Black cable for negative
- Fine-stranded copper conductor for maximum conductivity and flexibility
- Custom cables can be made to your specifications through our quickfigurator tool online. Visit www.quickfigurator.com to get started



GA	Color	Part No.
2	Positive	214941
1		214943
1/0		214945
2/0		214947
3/0		214949
4/0	214951	
2	Negative	214942
1		214944
1/0		214946
2/0		214948
3/0		214950
4/0	214952	

Leadheads - Standard Bore

- 15/16" post hole (.937", 24 mm)
- Silicone seal keeps moisture and acid out, extending cable life
- Made with welding cable, hot tinned for maximum conductivity, flexibility and best for corrosion resistance
- Black and red cables for easy polarity identification
- Custom cables can be made to your specifications through our quickfigurator tool online. Visit www.quickfigurator.com to get started

Straight

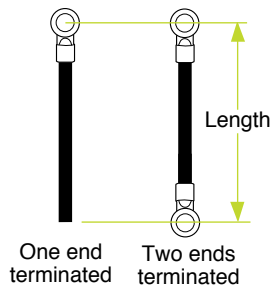

Cable GA	Length		Number of Ends Terminated	Part No.	
	Inches	Meters		Black	Red
2	60"	1.5	One	214137	214136
	120"	3.1	Two	214229	214230
1	60"	1.5	One	214223	214256
	120"	3.1	Two	214201	214234
1/0	60"	1.5	One	214331	214376
	120"	3.1	Two	214301	214346
2/0	60"	1.5	One	214481	214526
	120"	3.1	Two	214451	214496
3/0	60"	1.5	One	214631	214676
	120"	3.1	Two	214601	214646
4/0	60"	1.5	One	214780	214825
	120"	3.1	Two	214750	214795

Offset - One Post Hole

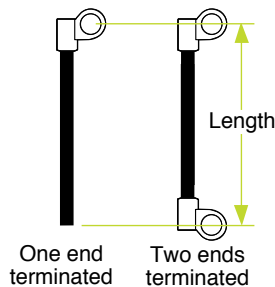

Cable GA	Length		Number of Ends Terminated	Part No.	
	Inches	Meters		Black	Red
2	60"	1.5	One	214105	214106
	120"	3.1	Two	214108	214103
1	60"	1.5	One	214224	214257
	120"	3.1	Two	214202	214235
1/0	60"	1.5	One	214332	214377
	120"	3.1	Two	214302	214347
2/0	60"	1.5	One	214482	214527
	120"	3.1	Two	214452	214497
3/0	60"	1.5	One	214632	214677
	120"	3.1	Two	214602	214647
4/0	60"	1.5	One	214781	214826
	120"	3.1	Two	214751	214796

Offset - Two Post Holes

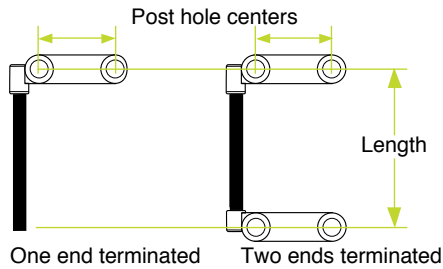

Cable GA	Length		Number of Ends Terminated	3.00" Hole Centers		3.75" Hole Centers	
	Inches	Meters		Black	Red	Black	Red
1/0	60"	1.5	One	214333	214378	214334	214379
	120"	3.1	Two	214303	214348	214304	214349
2/0	60"	1.5	One	214483	214528	214484	214529
	120"	3.1	Two	214453	214498	214454	214499
3/0	60"	1.5	One	214633	214678	214634	214679
	120"	3.1	Two	214603	214648	214604	214649
4/0	60"	1.5	One	214782	214827	214783	214828
	120"	3.1	Two	214752	214797	214753	214798

Offset - Three Post Holes

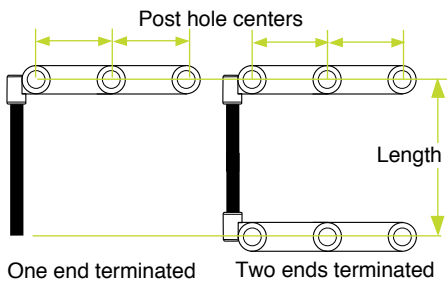

Cable GA	Length		Number of Ends Terminated	3.00" Hole Centers		3.75" Hole Centers	
	Inches	Meters		Black	Red	Black	Red
1/0	60"	1.5	One	214335	214380	214336	214381
	120"	3.1	Two	214305	214350	214306	214351
2/0	60"	1.5	One	214485	214530	214486	214531
	120"	3.1	Two	214455	214500	214456	214501
3/0	60"	1.5	One	214635	214680	214636	214681
	120"	3.1	Two	214605	214650	214606	214651
4/0	60"	1.5	One	214784	214829	214785	214830
	120"	3.1	Two	214754	214799	214755	214800

Small Bore

- 3/4" post hole (.75", 19 mm)
- Designed for SAE posts on deep-cycle batteries
- Silicone seal keeps moisture and acid out, extending cable life
- Fine-stranded copper conductor, for maximum conductivity, flexibility and corrosion resistance

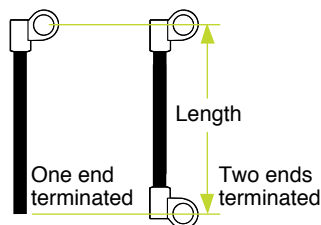

Cable GA	Length		Number of Ends Terminated	Part No.	
	Inches	Meters		Black	Red
2	60"	1.5	One	214124	214157
	120"	3.1	Two	214102	214135

Leadheads - Universal

- A straight-style leadhead, specially designed to be burned onto intercell connectors
- Reduce inventory of cables but maintain high levels of coverage
- Available in 60" and 120" pre-molded lengths
- Use with intercells or other leadheads
- Fine-stranded copper conductor, hot tinned, for maximum conductivity, flexibility and corrosion resistance
- Red or black insulation for easy polarity identification
- Allows you to locate negative and positive cables more conveniently for applications
- Use our leadhead post mold to make your power take-offs when burning on universal leadheads
- Internal silicone seal under insulation prevents corrosion, sealing out water and acid, a QuickCable exclusive

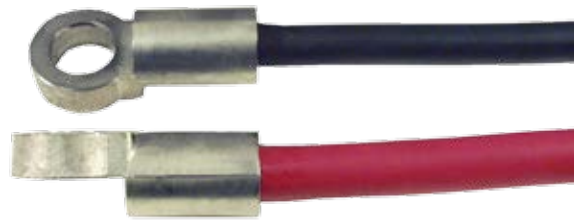

Cable GA	Length		Number of Ends Terminated	Part No.	
	Inches	Meters		Black	Red
1/0	60"	1.5	One	213451	213450
	120"	3.1	Two	213551	213550
2/0	60"	1.5	One	213453	213452
	120"	3.1	Two	213553	213552
3/0	60"	1.5	One	213455	213454
	120"	3.1	Two	213555	213554
4/0	60"	1.5	One	213457	213456
	120"	3.1	Two	213557	213556

Material Handling

Leadheads - Fast Charge

- Leadheads specifically engineered for fast charge or other high current applications
- Stock leadheads in 60 inch or 120 inch lengths
- Fine-stranded copper conductor, hot tinned, for maximum conductivity, flexibility and corrosion resistance
- Red or black insulation
- One hole offset leadhead
- Dual path leadhead - 3" and 3.75" centers
- Internal silicone seal under insulation prevents corrosion, sealing out water and acid, a QuickCable exclusive
- Custom leadheads made to your requirements
- Fast quotes and delivery

One Hole

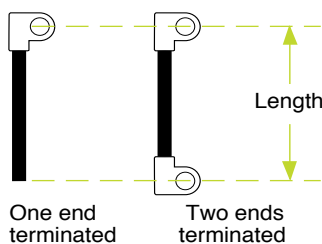

Cable GA	Length		Number of Ends Terminated	Part No.	
	Inches	Meters		Black	Red
2/0	60"	1.5	One	213053	213052
	120"	3.1	Two	213153	213152
3/0	60"	1.5	One	213055	213054
	120"	3.1	Two	213155	213154
4/0	60"	1.5	One	213057	213056
	120"	3.1	Two	213157	213156

Dual-Path

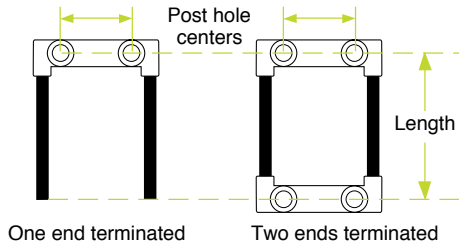

Cable GA	Length		Number of Ends Terminated	3.00" Hole Centers		3.75" Hole Centers	
	Inches	Meters		Black	Red	Black	Red
2/0	60"	1.5	One	213021	213020	213025	213024
	120"	3.1	Two	213121	213120	213125	213124
3/0	60"	1.5	One	213031	213030	213035	213034
	120"	3.1	Two	213131	213130	213135	213134
4/0	60"	1.5	One	213041	213040	213045	213044
	120"	3.1	Two	213141	213140	213145	213144

Post Mold

- Create a post on batteries or intercells
- Post mold is tall enough that when a leadhead is attached, the post will burn down and fill leadhead cavity, creating tight seal
- Enables you to add a leadhead where needed

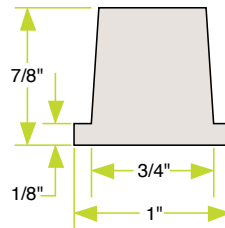

Description	Part No.
Leadhead post mold	213900

Material Handling

Leadhead Drill

- For leadheads, fast charge leadheads and intercells
- Extra tall flutes allow drilling depth of up to 1" post
- 1" OD leaves a .70" post
- Tool length 5"
- Center pin to guide drill straight
- Use centerless drill for deep bore



Extra tall flutes improve drilling depth in thick leadheads, wide flutes prevent chip pile-up

Three flats on shank prevent spinning in chuck



Description	Part No.
Leadhead drill - 2 flutes	9942
Centerless drill	9940

Carbon Arcing Cable Assembly

- Use the battery's power source to weld on leadheads and intercells
- Non-flame application
- 2 GA, 68" long flexible welding cable
- Heavy duty clamps



Description	Part No.
Welding cable assembly	213905

Notes:

CONTENTS OF THIS SECTION

ACCESSORIES

Accessories

Fuses & Breakers..... 83-85
 Fuse Kits85
 Fuse Holders, JumpStart Posts,
 Terminal Bus Bars, Distribution Posts 86-88
 Battery On/Off Switch.....88
 Wire Connectors for Copper Wire.....89
 Battery Vent Caps..... 89-90
 Water Sensor 90
 Battery Cap Tool 90



Fuses & Breakers

Standard Blade Fuses



Description	Color	Part No.
1 amp fuse	Gray	509121
2 amp fuse	Lt. Gray	509122
3 amp fuse	Violet	509123
4 amp fuse	Pink	509124
5 amp fuse	Tan	509125
7.5 amp fuse	Brown	509126
10 amp fuse	Red	509127
15 amp fuse	Blue	509128
20 amp fuse	Yellow	509129
25 amp fuse	Clear	509130
30 amp fuse	Green	509131
35 amp fuse	Purple	509132
40 amp fuse	Orange	509133

Glass Fuses



Description	Part No.
AGC - 3 amp	509201
AGC - 5 amp	509202
AGC - 7.5 amp	509203
AGC - 10 amp	509204
AGC - 15 amp	509205
AGC - 20 amp	509206
AGC - 25 amp	509207
AGC - 30 amp	509208
AGC - 35 amp	509209
SFE - 4 amp	509221
SFE - 7.5 amp	509222
SFE - 9 amp	509223
SFE - 14 amp	509224
SFE - 20 amp	509225
SFE - 30 amp	509226

Mini® Blade Fuses



Description	Color	Part No.
2 amp fuse	Lt. Gray	509101
3 amp fuse	Violet	509102
4 amp fuse	Pink	509103
5 amp fuse	Tan	509104
7.5 amp fuse	Brown	509105
10 amp fuse	Red	509106
15 amp fuse	Blue	509107
20 amp fuse	Yellow	509108
25 amp fuse	Clear	509109
30 amp fuse	Green	509110

Large Glass Power Fuses



Description	Part No.
AGU - G30 amp, gold plated	509230
AGU - G40 amp, gold plated	509231
AGU - G50 amp, gold plated	509232
AGU - G60 amp, gold plated	509233
ATM - 15 amp	509240
ATM - 30 amp	509245

Maxi Blade Fuses



Description	Color	Part No.
20 amp fuse	Yellow	509150
30 amp fuse	Green	509151
35 amp fuse	Pink	509152
40 amp fuse	Orange	509153
50 amp fuse	Red	509154
60 amp fuse	Blue	509155
70 amp fuse	Brown	509156
80 amp fuse	Clear	509157

Low Profile Fuses



Description	Color	Part No.
5 amp fuse	Tan	509183
7.5 amp fuse	Brown	509184
10 amp fuse	Red	509185
15 amp fuse	Blue	509186
20 amp fuse	Yellow	509187
25 amp fuse	Clear	509188
30 amp fuse	Green	509189

Access-A-Fuse

- 20 amp fuse with arm down
- Extra 7.5 amp fuse with arm up option
- Great for add-on accessories
- Terminates with .250 disconnect solderless terminal



Description	Part No.
Access-a-Fuse, 2 fuses in 1	509170

Auto Reset Blade 12V Type 1

- Complies with SAE standard J553



Description	Part No.
10 amp auto reset blade	509421
15 amp auto reset blade	509422
20 amp auto reset blade	509423
30 amp auto reset blade	509424

ANL Type Power Fuses



Description	Part No.
50 amp ANL power fuse	509298
80 amp ANL power fuse	509299
100 amp ANL power fuse	509300
150 amp ANL power fuse	509301
200 amp ANL power fuse	509302
250 amp ANL power fuse	509303
300 amp ANL power fuse	509304
350 amp ANL power fuse	509305
400 amp ANL power fuse	509306
450 amp ANL power fuse	509308
500 amp ANL power fuse (white)	509307

Auto Reset Circuit Breakers 6-24V Type 1

- Complies with SAE standard J553



Description	Part No.
15 amp – stud style/mounting bracket	509401
20 amp – stud style/mounting bracket	509402
30 amp – stud style/mounting bracket	509403
40 amp – stud style/mounting bracket	509404
15 amp – stud style/no mounting bracket	509411
20 amp – stud style/no mounting bracket	509412
30 amp – stud style/no mounting bracket	509413
40 amp – stud style/no mounting bracket	509414

ATC® Fuse Tap-In

- Used in domestic and imported cars
- Meets or exceeds OEM and SAE standards



Description	Fuse Tab Size	Part No.
Standard tab	.250	169146
Mini tab		169147

ATC/ATO Fuse Pullers



Description	Part No.
Standard blade fuse puller and tester	509701
Blade and Glass Fuse puller	509702

Water Resistant ANL Fuse Holder



Description	Part No.
ANL fuse holder to 1/0 gauge, water resistant	509661

Fuse Boxes –Standard Blade Fuses



Description	Part No.
8 position fuse box with lid .250 male side blade connections	509503

Manual Reset – 150 Amp Circuit Breaker

- Applications: typically used in auxiliary and accessory circuits-trucks, buses, RVs and marine applications
- Testing: complies with SAE J1625
- Housing: thermoset plastic; UL rated 94VO; +320° F (+155° C). Stud insulators are provided on covered units with type F (surface mount) bases
- Mounting: panel or surface



Description	Part No.
150 amp reset circuit breaker	509418

ANL Fuse Holder – Fuse Block Kit

- Stainless steel connector bolts
- Maximum voltage: 32 volts
- ANL fuse block kit includes 2 terminal protectors
- Plastic cover and terminal protectors protect the conductive area, complying with USCG and ABYC safety requirements



Description	Part No.
ANL fuse holder – fuse block kit	509665

MEGA® Fuse Holder – Fuse Block Kit

- Low cost solution to Mega fuse application
- Maximum voltage: 32 volts
- Mega fuse block kit includes 2 terminal protectors
- Plastic cover and terminal protectors protect the conductive area, complying with USCG and ABYC safety requirements



Description	Part No.
MEGA® fuse holder – fuse block kit	509666

Fuse Kits

- Most common sizes
- Convenient
- Comes in plastic storage box
- Mini® Blade Fuse Kit, 100 pcs.
- Standard Blade Fuse Kit, 120 pcs.
- MAXI® Blade Fuse Kit, 16 pcs.
- AGC® Glass Fuse Kit, 120 pcs.
- Mini®, Standard, MAXI®, AGC®, Fuse Kit, 325 pcs.

Description	Part No.
Mini® Blade Fuse Kit, 100 pcs.	509115
Standard Blade Fuse Kit, 120 pcs.	509140
MAXI® Blade Fuse Kit, 16 pcs.	509160
AGC® Glass Fuse Kit, 120 pcs.	509215
Mini®, Standard, MAXI®, AGC®, Fuse Kit, 325 pcs.	509200



509115



509140



509160



509215



509200

Fuses Holders, JumpStart Posts, Terminal Bus Bars, Distribution Posts

Mini® Blade Fuse Holder/Cap



Description	Part No.
14 GA to 20 amp, water-resistant	509601
12 GA to 30 amp, water-resistant	509602

Crimp Type Yellow AGC Fuse Holder



Description	Part No.
12-18 GA to 30 amp crimp type yellow fuse holder (W/P)	509640

ATC®/ATO® Standard Open Blade Fuse Holder



Description	Part No.
14 GA to 20 amp	509605
12 GA to 30 amp	509606

Panel Mount Glass AGC Fuse Holder



Description	Part No.
Panel mount glass fuse holder	509650

ATC®/ATO® Standard Blade Fuse Holder/Cap



Description	Part No.
14 GA to 20 amp, water-resistant	509611
12 GA to 30 amp, water-resistant	509612

AGU Fuse Block



Description	Part No.
Fuse block (waterproof) inline AGU Fuse holder to 4 gauge	509660

ATC®/ATO® Sealed Standard Blade Fuse Holder



Description	Part No.
Sealed, standard blade fuse holder 12 GA, 30 amp, water-resistant	509621

Self Stripping ATC®/ATO® Fuse Holder



Description	Part No.
Self stripping fuse holder, standard Blade, crimp-style 18-14 GA wire	169150

Maxi® Fuse Holder/Cap



Description	Part No.
Maxi fuse holder/cap 8 GA to 60 Amp, water-resistant	509631

AGC Glass Fuse Holders



Description	Part No.
14 gauge to 20 amp, nylon Glass AGC fuse holder	509641
12 gauge to 30 amp, nylon Glass AGC fuse holder	509642
Used with ATM fuse holder	509643

Junction Block Surface Mount

- Screw type or stud type
- Rated at 30 amps
- For use with 10-22 AWG wire



670177



670144

Description	Part No.
7 position block with cover	670177
4 position block	670144

Terminal Bus Bar

- Connects multiple cables to single source
- Positive post: 3/8", negative post: 5/16"
- Maximum voltage: 48 volts
- Bus strip: nickel-plated copper alloy
- Tab type bus bar accepts push-on type, quick disconnect terminals greatly increasing production

Description	Amps	Post	Part No.
4 position block	-	-	670144
4 point terminal bus bar – neg.	210	5/16"	509710
4 point terminal bus bar – pos.		3/8"	509711
12 point terminal bus bar – neg.	180	5/16"	509716
12 point terminal bus bar – pos.		3/8"	509717
Tab type bus bar – 10 points, 20 amps per connection			670178



670144



509711



509716



670178

Panel Bushings

- For use with up to 1/8" panel
- Meets UL - HB standard
- Easy to assemble, base material: glass-filled nylon
- Available colors: red or black
- Current rating: 300 amp (3/8") or 500 amp (1/2")
- Melting point is 395 °F (202°C)
- Weatherproofing meets SAE J2120 8.5, ABYC E9.YH and USCG 33CFR subpart 1

Description	Amps	Post	Part No.
Red bushing	300	3/8"	509670
Black bushing			509671
Red bushing – weatherproof	500	1/2"	509675
Black bushing – weatherproof			509676
Red bushing – weatherproof	300	3/8"	509677
Black bushing – weatherproof			509678
Red bushing – weatherproof			509668
Black bushing – weatherproof			509669



509668



509669



509670



509671



509677



509678

Jumpstart Connector Conductor Posts

- Provides connection on outside of machine when battery is not easily accessible or when reaching into the battery compartment is dangerous or difficult
- Conductor posts are mounted on the insulated pad with polarity colored protective caps (pos/red, neg/black)



Description	Part No.
Jumpstart connector conductor posts (positive and negative)	509699

Jumpstart Connector Plugs

- Similar to panel bushings
- Provides connection on outside of machine when battery is not easily accessible or when reaching into the battery compartment is dangerous or difficult
- Conductor posts are mounted on the insulated pad with polarity colored protective caps (pos/red, neg/black)



Description	Part No.
Single post negative jumpstart plug	509713
Single post positive jumpstart plug	509714

Power Distribution Post – Single-Point

- Available in large or small base
- Used to connect two or more voltage or negative return lines
- Available colors: red or black
- Base material: glass-filled nylon
- Stainless steel connector post



509690

509691

509697

509698

Description	Base	Amps	Post	Part No.
Single point post – red	Small	250	3/8"	509690
Single point post – black			5/16"	509691
Single point post – red		165	1/4"	509692
Single point post – black				509693
Single point post – red	Large	160	3/8"	509695
Single point post – black			5/16"	509696
Single point post – red		1/4"		509697
Single point post – black				509698

Power Distribution Post – 8 Point

- Base material: positive/red, negative/black glass filled nylon
- Positive post: 3/8", negative post 5/16"
- Kit packaging 1 wire, 2 wire, multiple wire entry
- Connecting plate is nickel-plated
- Creates reliable, trouble-free circuit path to control system



509680

Description	Amps	Post	Part No.
8 point distribution – pos./red	160	3/8"	509680
8 point distribution – neg./blk.		5/16"	509681
8 point distribution – 1 wire kit		–	509685
8 point distribution – 2 wire kit			509686
8 point dist. – three wire kit			509687

Battery On/Off Switch

- Prevent unauthorized use
- Eliminate battery discharging
- Protective boot/cap prevents corrosion
- Rated 200-amperes continuously at 12 volts
- Rated 500-amperes at 12 volts for 10 seconds
- 1" hole opening is required to mount switch boss
- Use four #10 machine screws with nuts and washers for mounting
- Uses 3/8" lug for connection



Description	Part No.
Battery on/off switch	309101
On/off key with brass pin	309102

Wire Connectors for Copper Wire ✓RoHS

- Use on solid or stranded copper wire
- Threaded steel insert permits positive bite
- Can be used with multiple wires
- UL/CSA listed where applicable
- Gray and blue rated 300V; orange, yellow and red rated 600V

Wire GA	Color	Part No.
24 - 16	Gray	169116
22 - 14	Blue	169117
20 - 14	Orange	169118
18 - 12	Yellow	169119
18 - 10	Red	169120



169116 169117 169118 169119 169120

Battery Vent Caps

Bayonet Vent Cap

- Replaces a standard cap
- Installs with 1/4 turn
- Comes in four colors: yellow, red, white and blue



Description	Part No.
Bayonet style vent cap – yellow	215900
Bayonet style vent cap – red	215907
Bayonet style vent cap – white	215908
Bayonet style vent cap – blue	215909

Econ-O-Flip Vent Cap

- No need to remove vent cap – flip and fill
- Installs with 1/4 turn
- Snap lock lid
- Design includes a flame and spark retardant barrier that allows gases to pass out of the battery



Description	Part No.
Econ-O-Flip style vent cap	215901

Watermiser Vent Cap

- No need to remove vent cap – flip and fill
- Installs with 1/4 turn
- Special medium in the cap collects electrolytes during charging and returns them to the battery
- Snap lock lid



Description	Part No.
Watermiser style vent cap	215902

Low Profile Vent Cap

- 1/2" high
- Installs with 1/4 turn
- Has acid splash baffle
- Reduces vapor loss



Description	Part No.
Low profile style vent cap	215903

High Profile Vent Cap

- 1" high
- Installs with 1/4 turn
- Has acid splash baffle
- Reduces vapor loss



Description	Part No.
High profile style vent cap	215904

Water Sensor

Probe Style

- Monitors for low water level
- Easy installation
- Installs in any cell
- Flashing green light indicates proper water level



Description	Part No.
Water me sensor – probe style	510332

Battery Cap Tool

- Makes it easy to remove and install bayonet style caps
- Ideal for industrial maintenance, golf carts, shops, etc.



Description	Part No.
Battery cap tool	215920



Notes:

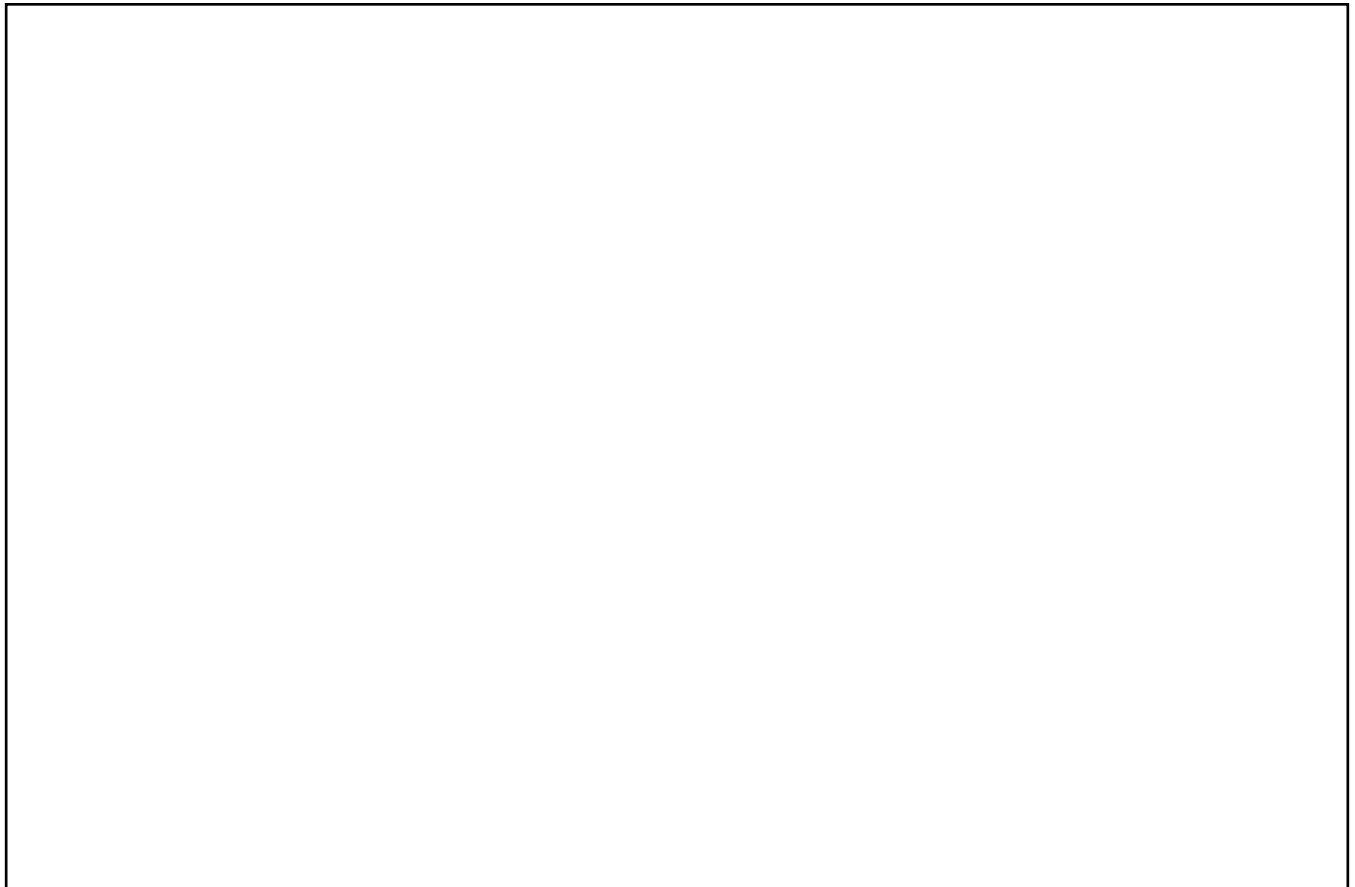

BATTERY BOXES

QuickBox® Battery Box Overview	93
QuickBox® Auto, Light Truck, Marine & RV	93
QuickBox® Single & Dual	94
QuickBox® Commercial Boxes.....	95
Quick® Battery Trays.....	96
QuickBox® Dimensions.....	97
Battery Box Vent Kit	97
Battery Relocation Kits	98
Hold-Downs & Rods	98-101
Battery Isolators.....	101
Battery Inverters	102
Inverter Installation Kits.....	103
MagnaLug™ Inverter Connector	103



QUICKBOX™ Battery Boxes

- Contain and restrain batteries for safety, and to comply with regulations
- Protect cables and connections
- Contain acid leaks to protect your equipment and the environment
- Protect batteries from external damage

The Engineered Advantages of QUICKBOX™

- More than 15 models to choose from – the widest selection in North America
- Temperature stable in heat and cold
- Chemical and impact resistant
- Multiple mounting options
- Precise battery fit
- Convenient cable routing
- Covers attach independently from mounting system
- Venting to prevent gas build-up
- Includes battery strap kit with mounting hardware



QUICKBOX™ Auto, Light Truck, Marine & RV

Fits All Batteries

- Fits all traditional battery group sizes
- Fits all new orbital or spiral celled, deep cycle, high performance batteries
- Convenient battery box application guide, see end of section

Mounting Holes in Handle

- Molded hold-down holes to reinforced handles
- Use J-hooks, L-hooks, threaded rod or lag bolts
- Remove the lid while keeping the box secure

QuickLock™ Cover

- Easy-on and easy-off
- Safe and secure
- Convenient, fast, durable
- QuickLock™ prevents cover loss
- Includes heavy-duty battery strap

Tougher Material

- Impact resistant to -30°F (-34°C)
- Heat stable to +200°F (+93°C)
- Meets U.S. Coast Guard Regulations 183.420 & ABYCE-10.7
- Impervious to acid, gasoline, oil and solvents
- Will not rust



U1
120170



24 Black
120171



27
120172



24, 27, 31
120173

Battery Group	Inside Dimensions			Outside Dimensions			Part No.
	Length	Width	Height	Length	Width	Height	
U1 black	8" (20.3 CM)	5-1/4" (13.3 CM)	7-15/16" (20.1 CM)	10-3/4" (27.9 CM)	7-1/2" (19.1 CM)	8-1/2" (21.6 CM)	120170
24 black	10-1/2" (26.7 CM)	7" (17.8 CM)	9-3/4" (24.8 CM)	13-1/2" (34.3 CM)	9-1/4" (23.5 CM)	10-1/4" (26 CM)	120171
24 white	10-1/2" (26.7 CM)	7" (17.8 CM)	9-3/4" (24.8 CM)	13-1/2" (34.3 CM)	9-1/4" (23.5 CM)	10-1/4" (26 CM)	120171
27 black	12-3/4" (32.4 CM)	7-1/4" (18.4 CM)	10" (25.4 CM)	16-1/8" (40.9 CM)	9-5/8" (24.4 CM)	10-7/8" (27.6 CM)	120172
Adj. 24, 27, 31 black	14-1/2" (36.8 CM)	7-1/4" (18.4 CM)	10-3/8" (26.3 CM)	17-3/4" (45.1 CM)	10-1/4" (26 CM)	10-7/8" (27.6 CM)	120173
Adj. 24, 27, 31 white	14-1/2" (36.8 CM)	7-1/4" (18.4 CM)	10-3/8" (26.3 CM)	17-3/4" (45.1 CM)	10-1/4" (26 CM)	10-7/8" (27.6 CM)	120173

QUICKBOX™ Single & Dual

Battery Boxes for 6-Volt, GC2 and 4D Batteries

- Depending on your space requirements, use two boxes side-by-side, end-to-end or use a dual box
- Rugged heavy wall polyethylene construction
- Impervious to acid, gasoline, oil and solvents
- Single box holds ONE 6-Volt battery
- Dual box holds TWO 6-Volt batteries
- Dual box is molded in black or white
- Flame retardant
- Heat stable and cold temperature impact resistant 200°F (93°C) to -30°F (-34°C)



Single 6-volt
120174



Dual 6-volt side-by-side,
black
120175



Dual 6-volt side-by-side,
white
120176



Dual 6-volt
end-to-end
120177

Typical Group Size	Typical Batteries in Array	Color	Inside Dimensions			Outside Dimensions			Part No.
			Length	Width	Height	Length	Width	Height	
6-volt/GC2	1	Black	10-3/4" (27.3 CM)	7-1/4" (18.4 CM)	12-1/4" (31.1 CM)	13-1/2" (34.3 CM)	9-1/4" (23.5 CM)	13" (33 CM)	120174
Side-by-Side									
Dual 6-volt/GC2	2	Black	15" (38.1 CM)	11" (27.9 CM)	13" (33 CM)	20" (50.8 CM)	14-1/2" (36.8 CM)	14-1/2" (36.8 CM)	120175
	2	White	15" (38.1 CM)	11" (27.9 CM)	13" (33 CM)	20" (50.8 CM)	14-1/2" (36.8 CM)	14-1/2" (36.8 CM)	120176
End-to-End									
Dual 6-volt single 4D GC2	2	Black	21-5/8" (55 CM)	9-1/2" (24.1 CM)	11-1/2" (29.2 CM)	26-3/4" (68 CM)	14" (35.6 CM)	12-3/4" (32.4 CM)	120177

Battery Box

QUICKBOX™ Commercial Boxes

- Rugged, durable, heavy wall construction
- Impervious to acid, gasoline, oil and solvents
- 3-4 way cable channels molded into design
- Large entry ports for heavy-duty cable
- Cover held firmly with convenient thumb screws, no special tools required
- Cover can be locked for protection and tamper resistance
- Vent holes in cover allow gases to escape,
- Accommodates a variety of mounting options; see mounting hardware
- Flame retardant
- Heat stable and cold temperature impact resistant 200°F (93°C) to -30°F (-34°C)



4D
120177



8D high
120178



Dual 8D end-to-end
120167



Dual 8D side-by-side
120168



Dual 27, 31
120215



L16, GC2
120166

Typical Group Size	Typical Batteries in Array	Color	Inside Dimensions			Outside Dimensions			Mounting Bracket	Part No.
			Length	Width	Height	Length	Width	Height		
4D	1	Black	21-5/8" (55 CM)	9-1/2" (24.1 CM)	11-1/2" (29.2 CM)	26-3/4" (68 CM)	14" (35.6 CM)	12-3/4" (32.4 CM)	-	120177
8D high	1	Black	21-5/8" (55 CM)	11-3/4" (29.8 CM)	13" (33 CM)	26-3/4" (68 CM)	16-1/2" (41.9 CM)	14" (35.6 CM)	-	120178
Dual 8D end-to-end	2	Black	42-1/2" (108 CM)	12" (30.5 CM)	10-3/4" (27.3 CM)	49-1/2" (125.7 CM)	18-1/4" (46.4 CM)	12-1/4" (31.1 CM)	-	120167
Dual 8D side-by-side	2	Black	21-1/2" (54.6 CM)	23-1/2" (59.7 CM)	10-3/4" (27.3 CM)	27" (68.6 CM)	29" (73.7 CM)	12-1/4" (31.1 CM)	-	120168
Dual 27, 31	2	Black	14" (35.6 CM)	15" (38.1 CM)	10-1/4" (26.0 CM)	20" (50.8 CM)	21" (53.3 CM)	12-1/2" (31.7)	120334 (kit)	120215
L16, GC2	4	Black	28-1/2" (72.4 CM)	17" (43.2 CM)	18" (45.7 CM)	36" (91.4 CM)	24" (61 CM)	21" (53.3 CM)	-	120166

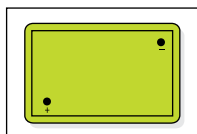

One battery in a box
120177

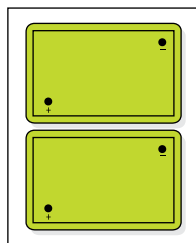

Two batteries in a
box, side by side
120168

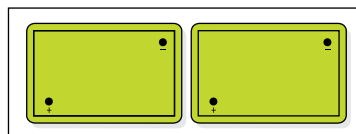

Two batteries in a box, end to end 120167

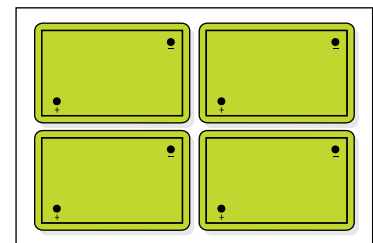

Four batteries in a box 120166

QUICK® Battery Trays

- Quick™ Battery Trays are made to work in standalone applications
- Heavy-gauge material, compare our trays to any others; we use thicker, stronger material to produce a rugged, durable product
- Trays will accommodate other batteries with similar footprints; for example Group 31 is similar to L16
- Single battery trays can be used to create unique battery layouts (side-by-side, end-to-end, spaced close together or far apart, etc.), and they can be easily moved or removed depending on your maintenance needs
- Multiple battery trays can hold 2, 3, 4 or more batteries, depending on the width and orientation of the batteries
- Trays can act as an acid containment system, either as a primary containment system or redundant to a floor-installed containment system
- Trays electrically isolate batteries from battery racks, as required by the National Electrical Code (NEC)
- Trays are made of HDPE which is impervious to acid, gasoline, oil and solvents
- Heat stable and cold temperature impact resistant -30°F to +170° F (-34° to +90° C)



Battery tray with three L16/GC2 batteries
120221



Battery tray with four L16/GC2 batteries
120220





Battery tray with four 8D/4D batteries
120225

Battery Box

Single Battery Trays

Battery Group	Inside Dimensions			Outside Dimensions			Part No.
	Length	Width	Height	Length	Width	Height	
L16, L16H, U3050, U3050HC	12-3/4" (32.4 CM)	7-1/4" (18.4 CM)	10" (25.4 CM)	16-1/4" (40.9 CM)	9-1/2" (24.4 CM)	10" (25.4 CM)	120189
GC2, GC2H, GC8, U2200, U2300, U2400, U2500, U2500HC	10-1/2" (26.7 CM)	7" (17.8 CM)	9-1/2" (21.4 CM)	13-1/2" (34.3 CM)	9-1/4" (23.5 CM)	9-1/2" (24.1 CM)	120187

Multiple Battery Trays & Pans

Type	Inside Dimensions			Outside Dimensions			Typical Battery Layout in Tray	Part No.
	Length	Width	Height	Length	Width	Height		
Tray	24-5/8" (62.6 CM)	14" (35.6 CM)	4-3/4" (12.0 CM)	27-1/4" (69.2 CM)	16-3/4" (42.5 CM)	5" (12.7 CM)	 Three L16/GC2	120221
Tray	46" (117.0 CM)	21-1/2" (55.0 CM)	4-3/4" (12.0 CM)	49" (124.5 CM)	24-1/4" (61.6 CM)	5" (12.7 CM)	 Four 8D/4D	120225

QUICKBOX™

Part Numbers with Dimensions

- All are made of polyethylene

Battery Group	Part No.	Finish	Inside Dimensions			Outside Dimensions		
			Length	Width	Height	Length	Width	Height
U1	120170	Black	8" (20.3 cm)	5-1/4" (13.3 cm)	7-15/16" (20.1 cm)	10-3/4" (27.3 cm)	7-1/2" (19.0 cm)	8-1/2" (21.6 cm)
24	120171	Black	10-1/2" (26.7 cm)	7" (17.8 cm)	9-3/4" (24.8 cm)	13-1/2" (34.3 cm)	9-1/4" (23.5 cm)	10-1/4" (26.0 cm)
24	120179	White	10-1/2" (26.7 cm)	7" (17.8 cm)	9-3/4" (24.8 cm)	13-1/2" (34.3 cm)	9-1/4" (23.5 cm)	10-1/4" (26.0 cm)
27	120172	Black	12-3/4" (32.4 cm)	7-1/4" (18.4 cm)	10" (25.4 cm)	16-1/8" (40.9 cm)	9-5/8" (24.4 cm)	10-7/8" (27.6 cm)
Dual 27-31	120215	Black	14" (35.6 cm)	15" (38.1 cm)	10-1/4" (26.1 cm)	20" (50.8 cm)	21" (53.3 cm)	12-1/2" (31.7 cm)
24, 27, 31 adjustable	120173	Black	14-1/2" (36.8 cm)	7-1/4" (18.4 cm)	10-3/8" (26.4 cm)	17-3/4" (45.1 cm)	10-1/4" (26.0 cm)	10-7/8" (27.6 cm)
24, 27, 31 adjustable	120193	White	14-1/2" (36.8 cm)	7-1/4" (18.4 cm)	10-3/8" (26.4 cm)	17-3/4" (45.1 cm)	10-1/4" (26.0 cm)	10-7/8" (27.6 cm)
6-volt/GC2	120174	Black	10-3/4" (27.3 cm)	7-1/4" (18.4 cm)	12-1/4" (31.1 cm)	13-1/2" (34.3 cm)	9-1/4" (23.5 cm)	13" (33.0 cm)
Dual 6-volt/GC2	120175	Black	15" (38.1 cm)	11" (27.9 cm)	13" (33.0 cm)	20" (50.8 cm)	14-1/2" (36.8 cm)	14-1/2" (36.8 cm)
Dual 6-volt/GC2	120176	White	15" (38.1 cm)	11" (27.9 cm)	13" (33.0 cm)	20" (50.8 cm)	14-1/2" (36.8 cm)	14-1/2" (36.8 cm)
Dual 6-volt/GC2 4D	120177	Black	21-5/8" (55 cm)	9-1/2" (24.1 cm)	11-1/2" (29.2 cm)	26-3/4" (68 cm)	14" (35.6 cm)	12-3/4" (32.4 cm)
8D high	120178	Black	21-5/8" (55 cm)	11-3/4" (29.8 cm)	13" (33.0 cm)	26-3/4" (68.0 cm)	16-1/2" (41.9 cm)	14" (35.6 cm)
L16 x 4 batteries	120166	Black	28-1/2" (72.4 cm)	17" (43.2 cm)	18" (45.7 cm)	36" (91.4 cm)	24" (61.0 cm)	21" (53.3 cm)
Dual 8D e/e	120167	Black	42-1/2" (108 cm)	12" (30.5 cm)	10-3/4" (27.3 cm)	49-1/2" (125.7 cm)	18-1/4" (46.4 cm)	12-1/4" (31.1 cm)
Dual 8D s/s	120168	Black	21-1/2" (54.6 cm)	23-1/2" (59.7 cm)	10-3/4" (27.3 cm)	27" (68.6 cm)	29" (73.7 cm)	12-1/4" (31.1 cm)

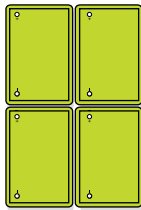

120166
Quad

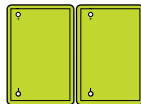

120168
Side-by-side



120167
End-to-end

Battery Box Vent Kit

- Contains all components needed for venting plastic QuickBoxes™



Kit Contains:		Part No.
Battery box flange 5' length, 2 holes	2 hose clamps Exterior vent cover	120328

Battery Relocation Kits

Relocation Kits without a Box: Top Post Battery

- Relocations kits allow easy access to the battery, letting you locate the battery where it is best for you
- Move battery weight in vehicle for performance and safety
- Multiple kits for different applications

Component Part	Part No.	Kit No.		
		308101	308103	308104
3' 2 GA black battery cable with top post connector	205501	X	-	X
20' 2 GA red battery cable with top post connector	205511	X	-	X
3' 2 GA black battery cable with top post and flag connector	205502	-	X	-
20' 2 gauge red battery cable with top post connector	205512	-	X	-
Battery tray	302123	X	X - 2	-
Universal battery hold-down	302201	X	X - 2	X
"J"-hooks	302108	X	X - 4	X
Braided ground strap	7105	X	-	X
12" x 3/8" threaded rod	302109	X	-	X
Hardware	N/A	X	X	X



308101



308103



308104

Hold-Downs & Rods for Batteries and Battery Boxes

Battery Trays - Poly-Coated and Vinyl-Coated Steel

- Vinyl coated steel resists corrosion and cold climate cracking, ideal for replacing rusted or damaged OEM style trays
- Drain slots prevent fluid accumulation and aligns with mount holes or brackets
- 11" tray is designed for standard Group 24 size batteries, also fits Groups 1, 2, 17, 22, 23, 42, 54, 55, 56, 72, and 74
- 13" tray is designed for standard Group 27 size batteries, also fits Groups 4, 29, 31, 53, 60 and 77
- Polyethylene tray will not rust



Polyethylene



Vinyl-coated steel

Battery Trays - Polyethylene

Description	Part No.
Battery tray, polyethylene - 11"	302120
Battery tray, polyethylene - 13"	302121

Battery Trays - Vinyl Coated Steel

Description	Part No.
Battery tray, vinyl coated - 11"	302122
Battery tray, vinyl coated - 13"	302123

Securing Base Mount Parts – Automotive & General - 4D/8D & Dual 6V Boxes

- Hold-down kits for securing 4D/8D and dual 6-volt boxes to work platform
- Zinc-plated fasteners
- Base mounts are vinyl-coated steel

Description	Part No.
Lag bolt and washer kit	420178
Bolt, nut and washer kit	420179-2001
GM/General base-mount hold-down	302203
Ford base-mount hold-down	302204



Lag bolts & washers
420178



Base mount
302203



Bolts and nuts
420179-2001

Mounting Brackets for Commercial Battery Boxes

- Designed to fit QuickBox commercial boxes by mounting to battery box
- Foot slots allow box to be positioned side-to-side or front to back depending on installation limitations
- Bracket includes hardware to connect to battery box



Description	Part No.
Four 4" mounting brackets w/ hardware	120334

Heavy Duty Tie Down

- HD replacement strap includes buckle, mounting brackets and 4 screws
- Made of polypropylene, impervious to battery acid (nylon straps break down in acid)



Description	Part No.
HD replacement strap, 40"	120156
Extra long HD strap, 54"	120159

QuickHold™ Adjustable Battery Hold-Downs

- Adjustable and lockable
- Fiberglass reinforced polypropylene is rust and corrosion-proof
- Non-conductive – eliminates hold-down as source of shorts
- Ideal for all applications – car, truck, bus, marine or recreational installations
- Fits existing hardware or select from hold-down bolts and Group 24 or 27 vinyl coated trays



Description	Min./Max. Extension	Part No.
Offset hold-down	4" – 6-1/8"	302101
Offset hold-down	5-1/2" – 9"	302102
Flush hold-down	8-5/8" – 14-3/4"	302103

Cross Bar Hold Down Bolt Sets - "L" Style and "J" Style

- Long thread accommodates all crossbar/frame designs including QuickHold products above
- Use with battery trays
- "L" style bend eliminates any need to shift or remove battery
- Sold as pair - hardware included



Adjustable cross bar



Center mount cross bar



Hold-down bolt sets - "L" style



Hold-down bolt sets - "J" style

Cross Bar Hold-Down - 6-7/8"

Description	Part No.
Adjustable cross bar hold-down	302201
Center mount cross bar hold-down	302202

Hold-Down Bolt Sets - "L" Style

Description	Part No.
8", hold-down bolt set, 1/4"(6mm) - "L" style	302104
10", hold-down bolt set, 1/4"(6mm) - "L" style	302105

Hold-Down Bolt Sets - "J" Style

Description	Part No.
8", hold-down bolt set, 1/4"(6mm) - "J" style	302106
10", hold-down bolt set, 1/4"(6mm) - "J" style	302107
12", hold-down bolt set, 1/4"(6mm) - "J" style	302112

Hold-Down Rods for Golf Carts

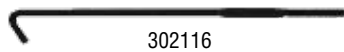

302116



302117



302118



302109



302126



302124



302125

Description	Length	Part No.
Yamaha electric except G22	11-9/16"	302116
Yamaha G22 series	10-9/16"	302117
Yamaha G29 gas electric 2007 up	12"	302118
Club car precedent	13-9/16"	302115
Club car, 1981 - 2006 DS	11-1/2"	302126
EZ-Go, 1994 - up	10"	302124
EZ-Go, 2008 - up RXV	13-1/4"	302125



Battery Rack Cable Kits

- Designed for Deep Cycle batteries used in stored electrical energy such as L16, GC2, T105, Group 27, Group 31, and equivalent
- UL listed connectors
- UL cable suitable for use in battery interconnections per NEC article 690.74
- 600 volts UL-type SC per NEC table 400-5 (B)
- Cable kits with disconnects include two 350 Amp SB® housings, one SB® mounting bracket, one SB® latching handle, and two cables from the batteries to the disconnect
- 8-Battery System comes with six short jumpers between batteries, one long jumper from upper to lower shelf



Cable Kits - with 350A SB® Disconnects

GA	Battery Group	8-Battery System	Kit Contains
2/0	L16	990170	Two 350 Amp SB housings, one SB mounting bracket, one SB latching handle and two cables from the batteries to the disconnect
	GC2	990171	
4/0	L16	990174	
	GC2	990175	

Cable Kits - without Disconnects

GA	Battery Group	8-Battery System	Kit Contains
2/0	L16	990172	Six short jumpers between batteries, one long jumper from upper to lower shelf
	GC2	990173	
4/0	L16	990176	
	GC2	990177	

Battery Isolators

- Ideal for marine, RV, automotive and commercial applications
- Allows for simultaneous battery charging of a multiple battery system
- Isolates batteries to insure power to start your vehicle
- Reliable solid-state circuitry
- Sealed to protect against oil, gas, salt, water and harsh environments
- Temperature range -40°F to +250°F (-40°C to +121°C)
- For lead acid wet cell or gel cell batteries, all batteries must be same type to prevent damage

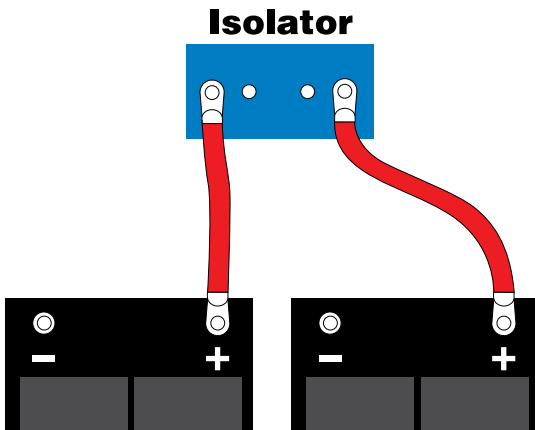

Isolator Types

Type	Description
Delcotron	(12-36V) Use with General Motors alternators for 1985 to 2006* vehicles that require an extra ignition connection terminal
Schottky	(6-36V) Use a Schottky diode to reduce radio frequency interference and to minimize voltage drop; complies with Spec. KKK-A1822C

Description	Rating	Batteries	Part No.
Standard	70 amp	3	303300
Delcotron	90 amp		303301
Schottky	100 amp	2	303302
Standard	120 amp		303303
Delcotron	140 amp		303304
Schottky	180 amp		303305
Delcotron	200 amp		303306

*2007 and newer GM vehicles require the use of separators



303304

Battery Inverters

- Convert DC to 120-Volt AC pure sine wave or modified sine wave inverters
- Low battery alarm
- Reverse polarity protection
- Overload protection
- High temperature protection
- Output short circuit protection

Comparison Wattage

Wattage	Continuous Power	Peak Power
150	150	450
300	300	1000
600	600	1500
1000	1000	2000
1500	1500	3000
2500	2500	5000

300-Watt Pure Sine Wave

- Precision power supply, ideal for computers, TVs and cell phones



12V Pure Sine Wave Inverter

Wattage	Part No.
300	303201

150-Watt to 600-Watt Modified Sine Wave

- One output
- Retail clamshells



12V Modified Sine Wave Inverter in Clamshell

Wattage	Part No.
150	303203
300	303204
600	303205

1000-Watt to 2500-Watt Modified Sine Wave

- Two outputs
- Ideal for general use

12V Modified Sine Wave Inverter

Wattage	Part No.
1000	303206
1500	303207
2500	303208



Inverter Remote Starter



Part No.
303220

Inverter Installation Kits

- Quick and easy installation of inverters
- All parts required for installation
- Easy-to-follow instructions
- Every kit includes inline fuse for safety



1000 Watt Kit

Description	Part No.
3 feet 4 GA AWG red cable	9944
10 feet 4 GA AWG red cable	
10 feet 4 GA AWG black cable	
10 feet 8 GA AWG green cable	
Deluxe clearview fuse holder	
150 amp safety fuses	
4 GA AWG wire connectors – Std., 3/8" hole	
4 GA AWG wire conn. – std., 5/16" hole	
4 GA AWG wire grommets	
8 GA AWG wire connectors – std., 1/4" hole	
Instructions	

2500 Watt Kit

Description	Part No.
3 feet 1/0 GA AWG red cable	9945
10 feet 1/0 GA AWG red cable	
10 feet 1/0 GA AWG black cable	
10 feet 8 GA AWG green cable	
Deluxe clearview fuse holder	
250 amp safety fuses	
1/0 AWG wire connectors – std., 3/8" hole	
1/0 AWG wire connectors – std., 5/16" hole	
8 GA AWG wire connectors – std., 1/4" hole	
1/0 GA grommets	
Instructions	

1500 Watt Kit

Description	Part No.
3 feet 2 GA AWG red cable	9946
10 feet 2 GA AWG red cable	
10 feet 2 GA AWG black cable	
10 feet 8 GA AWG green cable	
Deluxe clearview fuse holder	
200 Amp safety fuses	
2 GA AWG wire connectors - std., 3/8" hole	
2 GA AWG wire conn. - std., 5/16" Hole	
8 GA AWG wire connectors - std., 1/4" hole	
2 GA grommets	
Instructions	

Universal Kit

Description	Part No.
3 feet 2 GA AWG red cable	9943
10 feet 2 GA AWG red cable	
10 feet 2 GA AWG black cable	
10 feet 8 GA AWG green cable	
Deluxe clearview fuse holder	
150 amp safety fuses	
2 GA AWG wire connectors – std., 3/8" hole	
2 GA AWG wire conn. – std., 5/16" hole	
8 GA AWG wire connectors – std., 1/4" hole	
Cable ties	
Instructions	

Battery Box

MagnaLug® Inverter Connectors

- Can be crimped or soldered
- Permanent connection, prevents arcing and shorting
- Perfect fit for most inverter connections with screw tab mounting holes
- Unique self-centering design



MagnaLug® inverter connector

Gauge	Tab Length	Tab Width	Thickness	Part No.
8	.67"	.21"	.15"	102808
6				102806
4				102804
2				102802
2/0				102820

TOOLS, TESTERS & CHARGERS

- Cable Crimpers.....105-106
- Quick® Crimp Pneumatic 107
- Cable Strippers..... 108
- Cable Cutters109
- Primary Wire Tools109-110
- Cable Ties Tools110
- Battery Maintenance Tools 111-113
- Quick® Heat Guns 114-115
- iQ Charger & Maintainer..... 115
- Handheld Battery Testers 116-118
- Bench top Battery Testers 119-120
- Microprocessor Chargers.....121-123
- Bus Chargers.....123-125
- AutoMeter® Accessories 125
- Battery Testers 126



Tools, Testers & Chargers





2 Year Limited Warranty

Cable Crimpers

Quick® Crimp 250, 250 Pro & Quick® Crimp 100

- Comfortable hand grips
- Application data listed on tool
- Adjustable rotating dies always in tool
- Crimps 8 GA - 250 MCM
- Bench-mount also attaches to wall, service truck, etc.
- All Quick bench crimpers now feature Reactive Load (RL) Technology reducing crimp effort by 30%
- Engineered and manufactured in the U.S.A.



Style	Crimp Options				
	 Quick Crimp 250 Pro	 Quick Crimp 250	 Quick Diamond Crimp	 Quick Crimp 100	Quick MAX Lug Crimp Tool
	Length 34"	Length 26"	Length 26"	Length 19"	Length 26"
Handheld	4258	4255	4252	4247	4254
Handheld w/Ratchet	4258R	4255R	4252R	4247R	4254R
Bench-Mount	4258M	4255M	4252M		4254M
Bench-Mt. w/Ratchet	4258MR	4255MR	4252MR	-	4254MR



4258



Tools, Testers & Chargers

Service Parts for Crimpers



4255K

Crimper Type	Description	Part No.
Quick® Crimp 100	Two color-coded Quick Crimp 100 dies, 8 through 1 GA	4247D
Quick® Crimp 100	Two color-coded Quick Crimp 100 dies, two conical springs, four snap rings and two hardened hex pins	4247K
Quick® Diamond Crimp	Two color-coded diamond dies, 8 through 250 MCM	4252D
Quick Diamond Crimp	Two color-coded diamond dies, two conical springs, four snap rings and two hardened hex pins	4252K
MAX™ Lug Crimp	Two color-coded hex dies	4254D
Quick® Crimp 250	Two color-coded hex dies	4255D
Quick® Crimp 250	Two color-coded hex dies, two conical springs, four snap rings and two hardened hex pins	4255K
Quick® Crimp 250	Universal die set	4255UDK
All	Two conical springs, four snap rings	4257

Quick® Crimp 250 kit 4255-001K

Cub Crimper

- Designed for light and medium-duty applications
- Crimps cast copper connectors 8 GA to 1 GA and MAX™ Lugs and MagnaLugs™ up to 1 GA
- Adjustable crimp dies are always in tool
- Comfortable insulated grips; 15" overall length



Description	Part No.
Cub crimper - Lever style crimping tool	4245
Cub repair kit - Two hex dies, 8 thru 1/0 GA. Two pins with springs, two "L" brackets and two nuts	4245K

Tools, Testers & Chargers

Brute Hammer Crimper

- Inexpensive and simple crimping tool
- Crimps 8 - 4/0 GA
- Spring-loaded pin locks in "up" position for loading connector and cable; when released, pin holds connector securely during crimping



Description	Part No.
Brute hammer style crimping tool – crimps connectors 8 thru 4/0 GA	4266

Quick® Crimp Pneumatic

- The Quick® Crimp Pneumatic is a second generation, fully-automatic air-powered crimp tool designed for high volume cable crimping. It operates on standard shop air, 80-100 psi (5.5-7.0 bar) and develops up to 20,000 pounds of crimp force (88,900 N)
- Crimps all styles of battery and electrical connectors 8 GA-4/0
- Uses standard QuickCable crimp dies
- 3 second quiet crimp cycle
- Pullout tests exceed UL requirements
- Automatic controls to insure complete crimp cycle
- Turnkey operation: bolt it down, connect the air supply and go to work
- Heavy-duty heat-treated and powder coated steel frame
- Overall 28"L x 16"W x 27.5"H (71 x 40.5 x 70 cm)
- Weight 130 lb. (59 kg)
- Requires 3/8" (10mm) mounting bolts
- Manufactured by QuickCable in U.S.A.
- Quick die change without tools



Safety Features

- Guarded foot control
- Lexan® guard with safety interlock for crimp area

Description	Part No.
Quick Crimp Pneumatic Machine	420550

Dies for Quick® Crimp Pneumatic

Description	Part No.
Hex	4255D
Diamond	4252D
MAX Lug	4254D
Lead Free (B Crimp)	420506
Universal A	4255UDA
Universal B	4255UDB

Dies for P/N 420500 HexCrimp Pneumatic

- Hex Crimp Pneumatic requires special die sets. However, tools can be retrofitted to use all standard die sets. Contact QuickCable for more information

Description	Part No.
Hex	420501
MAX Lug	420507

Cable Strippers

QuickStrip[®] LS

LINEAR CABLE STRIPPER

- Industrial quality, strips up to 1000 feet / 300 meters of cable per hour, 8 GA to 4/0 and 250 MCM
- Bare copper has a higher scrap value than insulated cable
- Designed for stranded copper cable insulated with plastic or rubber such as EPDM, Neoprene[®], PE, PP, PVC, TPE, TPR, etc., with or without paper, jute or foil liner
- Primary wire guide for 16 - 10 wire GA
- Machine comes with cutting blade, hardened M2 tool steel (replacements available) and hex key for installation of cable guides
- Cable guides sold separately; guides are required and do not come with the machine
- One-year limited warranty on machine
- Engineered and manufactured in the U.S.A. by QuickCable



Machine Specifications

- 6" x 4" x 4.25" (15 x 10 x 11 cm)
- 3.6 pounds (1.64 kg)
- Two mounting holes in the base for 3/8"/10 mm bolts

Description	Part No.
QuickStrip LS – linear cable stripper. Requires cable guides as shown below.	420201
Cable Guides	
Cable guide, 8 – 6 GA	420221
Cable guide, 4 – 1/0 GA	420222
Cable guide, 1/0 GA – 250 MCM	420223
Cable guides (set of 3) 8 – 250 MCM	420230
Primary wire guide, 16 – 10 GA	420224
Replacement Blade	
Cutting blade	420241

QuickStrip[™] Cable Strippers

- Strip up to 777 MCM cable
- Includes spare blade



Description	Part No.
QuickStrip [™] battery cable stripper – Strips insulation from cable 10 to 4/0 GA	4215
Replacement blade	4216
QuickStrip [™] Pro battery cable stripper – Has two cable holders; strips 10 gauge to 777 MCM	4217
Replacement blade	4218

Tools, Testers & Chargers

Cable Cutters

QuickCutter™ 250 and QuickCutter™ 500

- Hand held and bench mount models
- Bench mount also attaches to wall, service truck, etc.
- QuickCutter 250 has 22" overall length for easier cutting
- Blades made of 1075 carbon steel, hardened for long life
- For copper cable only
- Engineered and manufactured in the U.S.A.



Description	Part No.
QuickCutter 250 – hand held cutter up to 6/0 (250 MCM)	4285
QuickCutter 250 – bench mount cutter up to 6/0 (250 MCM)	4285M
QuickCutter 500 – bench mount cutter up to 500 MCM	4287M

QuickCutter™ 1

- Cuts cable up to 2/0 GA
- 9 inch size, fits any tool box
- Ergonomic, insulated grips



Description	Part No.
QuickCutter™ 1 – made of forged steel with insulated grips. Cuts cable up to 2/0 GA	4275

Primary Wire Tools

Heavy Duty Cutter/Crimper

- Cuts and strips copper wire 22-10 GA stranded or 18-8 AWG solid conductor
- Crimps insulated and non-insulated connectors
- Cuts 4-40, 6-32, 8-32, 10-24 and 10-32 bolts



Description	Part No.
Heavy-duty cutter/crimper	420183

Cutter/Stripper with Pliers

- Cuts, strips and crimps as standard tool, but adds serrated plier nose and metric stripping
- Cuts 6-32, 8-32 and 10-32 bolts as well as M3.5, M4 and M5 metric sizes



Description	Part No.
Cutter/stripper with pliers	420186

Standard Cutter/Crimper Tool

- Cuts and strips wire 22-10 GA
- Crimps insulated and non-insulated connectors
- Cuts 4-40, 6-32, 10-24 and 10-32 bolts



Description	Part No.
Standard cutter/crimper tool	420193

Electrician's Automatic Wire Stripper

- Cuts and removes jacket all in one motion
- Professional grade



Description	Part No.
Electrician's automatic wire stripper	420192

Heavy Duty Ratchet Crimpers

- Three jaw styles: PVC, OEM, Gardian™ terminals
- Ratchet requires full crimp before reopening



Description	Part No.
Ratchet crimper – Gardian- terminals	420187
Ratchet crimper/non-insulated – OEM terminals	420188
Ratchet crimper – PVC terminals	420189
Ratchet crimper – Heat shrink terminals	165800

Wire Stripper

- Cuts and strips wire GA 24-10
- Convenient spring action



Description	Part No.
Wire stripper	420190

Wire Loom Cutting Tool

- Cutting tool for loom and tubing



Description	Part No.
Loom cutting tool	505900

Cable Ties Tools

- For ties from 18 up to 175 lbs.



502900



502901



502903



502902



502904

Description	Part No.
Light-duty cable tie tool – 18 - 50 lbs.	502900
Heavy-duty cable tie tool – 18 - 50 lbs.	502901
Heavy-duty cable tie tool – 120 - 175 lbs.	502902
Cable tie tool – plastic 18 - 50 lbs.	502903
Heavy-duty cable tie cutter and stripping tool	502904

Battery Maintenance Tools

Hydrometers

- Professional quality for highest accuracy
- Precision graduated specific gravity float



Picture	Description	Part No.
A	Mini hydrometer - plastic	120147
B	Commercial hydrometer - plastic	120149
C	Commercial hydrometer - glass	120152

Pointer Style Hydrometer

- Thick wall plastic body resists breakage
- Direct dial scale features oversize markings
- Step-by-step instructions on body



Description	Part No.
Pointer hydrometer tester - plastic	120151

Filler Bulb

- Acid-resistant rubber bulb, 6 oz. capacity
- Flexible 6" vinyl nozzle for easy vent access
- Bulb stores upright - eliminates acid drip



120162



120161

Description	Part No.
Battery filler bulb	120162
Battery filler jug	120161

Filler Jug

- Automatic filler stops flow at proper level
- Acid-proof polyethylene
- 2-quart capacity, can be used with acid or water

Circuit Tester

- Works on 6, 12 or 24-volt circuits
- Screw cap protects insulation probe
- Chrome plated solid brass body



Description	Part No.
Chrome plated electric circuit tester	420184

Safety Glasses

- Protects eyes from acid splatter or explosion
- Molded polycarbonate with side shields



Description	Part No.
Polycarbonate safety glasses	120101

Side Terminal Brush

- Brass wires securely embedded on two sides
- Shaped to clean terminals, connectors and bolts
- 5/16" hex in handle services GM connectors



Description	Part No.
Brass side terminal brush	120122

Power Brush

- Fits 3/8" power drill chuck



120117

Description	Part No.
Power brush – marine	120117
Power brush – standard	120118
Power brush – side terminal	120119
Power brush – group 31 and GC2	120120

Side Terminal Ratchet Wrenches

- Reversible ratchet wrench
- Installs and removes 5/16" and 10 mm terminals



120200

Description	Part No.
Battery Side Terminal Ratchet - 5/16"	120195
Side Terminal Ratchet - 5/16"	120200
Side Terminal Ratchet - long handle 5/16"	120201

Post Terminal Brush

- Corrosion-resistant, self-contained brush set
- Inner bristles clean post terminals
- Conical outer bristles clean cable connectors



Description	Part No.
Post terminal brush	120121

3 in 1 Brush

- Post terminal
- Side terminal
- Auxiliary brush



Description	Part No.
3-in-1 brush – post terminal, side terminal, auxiliary brush	120110

Angled Battery Pliers

- Offset nose designed for close quarter work
- Narrow jaws securely grip corroded hardware
- Insulated handles reduces short circuit risk



Description	Part No.
Angled battery pliers	120194

Clamp Connector Lifter

- Removes connector without damaging top post
- Adjusts to any clamp connector width and thickness
- Vinyl-dipped non-slip handles resists acid



Description	Part No.
Clamp connector lifter	120191

Clamp Spreader/Reamer

- Forged steel design evenly spreads connector
- Use serration to ream clamp
- Vinyl-dipped non-slip handles resists acid

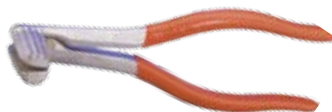

Description	Part No.
Clamp spreader/reamer	120192

Strap Carriers

- Economical design for post terminal use only
- Double grip jaws lock automatically
- Non-conductive plastic strap is acid-resistant



120160



120154

Side Lift Carrier

- Best quality for all battery types and sizes
- Adjustable notches securely lock in place
- Features bicycle grip handle and sidewall pads



120155



120153

Scissors Carriers

- For use with side or top terminal batteries
- Self-adjusting jaw fits up through Group 31
- Reinforced rubber strap is non-conductive

Description	Part No.
Scissors battery carrier – standard	120153
Side lift battery carrier	120154
Strap battery carrier	120155
Scissors battery carrier – wide	120158
Strap battery carrier	120160

Quick® Heat Guns

Accessories and Replacement Parts

- QuickHeat guns provide convenient, controlled heat output for professional installation of heat-shrink tubing
- Flameless heat reduces risks associated with open torches
- QuickHeat 1 gun is ETL and CETL approved and features adjustable heat output 250°F (121°C) to 1100°F (593°C)
- QuickHeat 2 is an industrial grade, UL and CSA approved heat gun featuring fully adjustable air flow, sturdy adjustable stand, quick change MICA break-resistant heat element, includes stand
- Tube deflectors included, replacements available



QuickHeat 1 and 2

Description	Part No.
QuickHeat 1 High impact plastic housing, dual heat 250°/1100° F output, 120V/1200W; includes heat deflector	4271
QuickHeat 2 High impact plastic housing, dual heat 500°/750° F output. Replaceable brushes and heat element, 120V/1200W; includes heat deflector, includes stand	4272



Tools, Testers & Chargers

Deflector Replacement

- Replacement heat-shrink tube deflectors
- Used with QuickHeat 1 or 2



Description	Part No.
Replacement heat shrink tube deflector for QuickHeat 1	4277

Flameless Heat Gun

- Perfect for Gardian™ heat-shrink terminals
- Can be used to shrink heat-shrink tubing
- Self-starting with safety lock
- Disposable lighter (included)
- Windproof/waterproof design



Description	Part No.
Flameless heat gun	4273

Butane Torch

- Self-starting with safety lock
- Can be used for soldering and brazing
- Temperature +2372°F (+1300°C)
- Can be used with Fusion™ connectors
- Burning time is 60-70 minutes
- Refillable, butane not included



Description	Part No.
Butane torch	4280

iQ Charger & Maintainer

iQ4 - Part No. 608002



Battery Type: Flooded Lead Acid AGM, Gel
Voltage: 6V & 12V



Charger Rate: Automatic Microprocessor Controlled
Output: 12V @ 4A, 12V @ 1A, 6V @ 4A



Cable Length: AC/DC: 5.9', 18 AWG



In-Line Fuse: 15 Amp



Warranty: 2 Year

Accessories/Features: 9-Stage Battery Maintenance, LED Indicators, In-Line Fuse, IP65 Rating



NEW!

iQ2 - Part No. 608001



Battery Type: Flooded Lead Acid AGM, Gel
Voltage: 12V



Charger Rate: Automatic



Output: 12V @ 2A



Cable Length: AC/DC: 5.9', 18 AWG

In-Line Fuse: 15 Amp

Warranty: 2 Year

Accessories/Features: 3-Stage Battery Maintenance, LED Indicators, In-Line Fuse, IP65 Rating



NEW!



Handheld Battery Testers

Technician Grade

Technician grade handheld battery testers are microprocessor controlled testers capable of delivering 40 amp load tests. Each unit is designed to test flooded and AGM batteries in various states-of-charge. Testers have a 16 character 4 line LCD screen that will store the last 150 tests in memory and can be used with an optional PR-12 infrared printer or can be linked to a computer. Each unit is reverse polarity protected, durable plastic case with rubber easy-grip boot.

SB-300 - Part No. 303100

- Designed for general automotive battery testing only

Battery Voltage: 6V & 12V
Battery Range: 100-1600 CCA
Automated Load: 40 Amp
Memory: 150 Tests
Operational Temp: 0-120°F
Language: English, Spanish & French
Dimensions: 4.5" x 7.1" x 1.4"
Cooling: Vented
Internal Battery: 9VDC
Voltmeter Range: 0-30



RC-300 - Part No. 303110

- Designed to test deep cycle sealed lead acid batteries

Battery Voltage: 6V & 12V
Battery Range: 4Ah-50Ah
Automated Load: 40 Amp
Memory: 150 Tests
Operational Temp: 0-120°F
Language: English, Spanish & French
Dimensions: 4.5" x 7.1" x 1.4"
Cooling: Vented
Internal Battery: 9VDC
Voltmeter Range: 0-30



BVA-300 - Part No. 303115

- Performs full automotive electrical system tests (battery, starter, alternator)

Battery Voltage: 6V & 12V
Battery Range: 100-1600 CCA
Automated Load: 40 Amp
Memory: 150 Tests
Operational Temp: 0-120°F
Language: English, Spanish & French
Dimensions: 4.5" x 7.1" x 1.4"
Cooling: Vented
Internal Battery: 9VDC
Voltmeter Range: 0-30





Handheld Battery Testers (Continued)

BVA-350

- Technician grade designed for both automotive and heavy duty truck diagnostics, perform full electrical system and "voltage drop" testing
- Includes: Alternator Test, Stator Diode Test, Starter Draw Test, Voltage Drop Test, External Volt Leads

Battery Voltage: 6V & 12V
Battery Range: 100-1600 CCA
Automated Load: 40 Amp
Memory: 50 Tests
Operational Temp: 0-120°F
Language: English, Spanish & French
Dimensions: 4.5" x 7.1" x 1.4"
Cooling: Vented
Internal Battery: 9VDC
Voltmeter Range: 0-30



NEW!

Professional Grade

Professional grade tester designed for frequent use in severe environments. Testers are microprocessor controlled and capable of delivering 120 amp load tests. Each unit is designed to test flooded and AGM batteries in various states-of-charges. Testers have a 16 character 4 line LCD screen that will store the last 150 tests in memory and can be used with an optional PR-12 infrared printer, or can be linked to a computer. Reverse polarity protection, durable metal case with rubber insulator boot.

BVA-230

- Tests single 12V batteries and includes standard clamps

Battery Voltage: 6V & 12V
Battery Range: 100-1600 CCA, 10-260 Ah
Automated Load: 120 Amp
Automated Test: 12V & 24V starting/charging
Stator Diode/Draw Test: Yes
Memory: 150 Tests
Operational Temp: 0-120°F
Language: English, Spanish
Dimensions: 5.9" x 9.6" x 2.1"
Cooling: Vented
Internal Battery: 9VDC



NEW!



Handheld Battery Testers (Continued)

BVA-260

- Tests single 12V batteries and includes side terminal smart clamps, USB port and built-in infrared battery temp sensor

Battery Voltage: 6V & 12V
Battery Range: 100-1600 CCA, 10-260 Ah
Automated Load: 120 Amp
Automated Test: 12V & 24V starting/charging
Stator Diode/Draw Test: Yes
Memory: 150 Tests
Operational Temp: 0-120°F
Language: English, Spanish
Dimensions: 5.9" x 9.6" x 2.1"
Cooling: Vented
Internal Battery: 9VDC



NEW!

BCT-200J

- Professional grade tester designed for both automotive and heavy duty truck diagnostics, perform full electrical system and "voltage drop" testing
- Carrying case, printer and alternator adaptor studs, all included.

Battery Voltage: 6V & 12V
Battery Range: 100-1600 CCA, 10-260 Ah
Automated Load: 120 Amp
Automated Test: 12V & 24V starting/charging
Stator Diode/Draw Test: Yes
Memory: 120 Tests
Operational Temp: 0-120°F
Language: English, Spanish
Dimensions: 5.9" x 9.6" x 2.1"
Cooling: Vented
Internal Battery: 9VDC



NEW!



Benchtop Battery Testers

Carbon pile testers are designed for those who want a traditional tester for batteries and electrical systems. These testers feature an end user adjustable variable load to test batteries per the Battery Council International (BCI) testing protocol. All batteries must be charged to 12.6V and at room temperature for testing. A fifteen (15) second long amp rated load equal to one-half the battery's CCA rating is applied and results are measured utilizing the tester's voltmeter and ammeter.

SB-3

- A single stack carbon pile bench tester capable of delivering up to 500 amps and up to 1000 CCA to test 12V batteries

12V Carbon Pile Load: 500 Amp Max
6V Carbon Pile Load: 250 Amp Max
Battery Range: 0-1000 CCA
Alternator Test: 12V Charge Voltage
Stator Diode Test: N/A
Starter Draw Test: Simulated
Operational Temp: N/A
Language: English
Dimensions: 10" x 10.5" x 4"
Cooling: Vented
Voltmeter Scale: 0-16



NEW!

SB-5/2

- Utilizes dual stack carbon piles to deliver up to 800 amps and up to 1600 CCA for both 6V and 12V Batteries, features a built-in fifteen (15) second timer and cooling fan

12V Carbon Pile Load: 800 Amp Max
6V Carbon Pile Load: 400 Amp Max
Battery Range: 0-1600 CCA
Alternator Test: 12V Charge Voltage
Stator Diode Test: N/A
Starter Draw Test: Simulated
Operational Temp: N/A
Language: English
Dimensions: 10" x 9" x 11"
Cooling: 5" Fan
Voltmeter Scale: 0-16



NEW!



Benchtop Battery Testers (Continued)

BVA-34

- Utilizes dual stack carbon piles to deliver up to 800 amps and up to 1600 CCA for both 6V and 12V Batteries, features a built-in fifteen (15) second timer and cooling fan, includes detachable test leads for voltage drop testing and detachable inductive amp clamp.

12V Carbon Pile Load: 800 Amp Max
 6V Carbon Pile Load: 800 Amp Max
 Battery Range: 0-1600 CCA
 Alternator Test: 12V & 24V
 Stator Diode Test: Yes
 Starter Draw Test: Yes
 Operational Temp: N/A
 Language: English
 Dimensions: 10" x 9" x 11"
 Cooling: 5" Fan
 Voltmeter Scale: 0-19.99/20 - 199.9



NEW!

BVA-36/2

- A carbon pile tester designed for heavy truck applications to deliver up to 800 amps and up to 1600 CCA for both 6V and 12V batteries, features a built-in fifteen (15) second timer and cooling fan, includes detachable test leads for voltage drop testing and detachable inductive amp clamp.

12V Carbon Pile Load: 800 Amp Max
 6V Carbon Pile Load: 800 Amp Max
 Battery Range: 0-1600 CCA
 Alternator Test: 12V & 24V
 Stator Diode Test: Yes
 Starter Draw Test: Yes
 Operational Temp: N/A
 Language: English
 Dimensions: 10" x 9" x 11"
 Cooling: 5" Fan
 Voltmeter Scale: 0-19.99/20 - 199.9



NEW!

AutoMeter



Microprocessor Chargers

Microprocessor testers are AutoMeter's newest generation, top of the line testers which incorporate Battery Council International (BCI) test criteria into an automated process. This test equipment is rated for automotive and heavy duty truck applications. Through simple navigation of the interface screen end users are prompted to enter battery status information (battery CCA rating, type and temperature), which then triggers the unit to automatically apply appropriate load and define test results.

BVA-2100

- Features two separate menus for automotive and heavy duty truck applications
- Delivers up to 400 amp automated load to accurately test 6v and 12v batteries rated up to 1600 CCAs
- Evaluates heavy duty truck electrical systems with the ability to test four (4) batteries at a time
- Voltage drop testing for starting/charging, magnetic switch, lift-gate and stinger cable circuit tests
- Tests and provides alternator amperage output and starting current draw test results
- Performs a two (2) minute preventative maintenance evaluation to quickly isolate electrical issues

Battery Voltage: 6V, 12V & 24V
Battery Range: 100-1600 CCA
Battery Type: Flooded and AGM
Automated Load: 400 Amp
Alternator/Stator/Starter: Yes
Memory: 150 Tests
Operational Temp: 0-120°F
Language: English, Spanish & French
Dimensions: 9.5" x 12" x 13"
Cooling: 5" Fan



NEW!





Microprocessor Chargers (Continued)

XCPRO-80

The XCPRO-80 is a microprocessor controlled charger that is fully automated and capable of charging all types of automotive batteries including flooded, sealed lead acid, AGM and Gel batteries. This charger offers two (2) options for charging; fast charge (approx. 40 minutes) up to 80% of capacity charge and full charge (approx. 40 minutes) up to 100% of capacity charge.

XCPRO-80

- Maintains precise control of charge current (2 to 80 amp output) and voltage utilizing a unique 4 channel X 20 amp/channel output
- Charges three battery voltage ratings: 6v, 8v and 12v
- Equipped with built-in battery temperature sensor to safely maximize battery charge output and to shut down charging if battery temp increases to quickly
- Time calculator displays charge time remaining in both fast and full charge settings
- Patented smart clamps with built-in side post battery connectors

Battery Voltage: 6V, 12V & 24V
Battery Range: N/A
Battery Type: Flooded and AGM
Automated Load: Up to 80 Amp Max
Operational Temp: 0-120°F
Language: English & Spanish
Dimensions: 11" x 8.5" x 10.5"
Cooling: 5" Fan



NEW!

QUICKCABLE®

XTC-160

The XTC-160 is a microprocessor controlled combination charger/tester that is AutoMeter's next generation unit for all-in-one testing and charging. This unit will accurately test 6V and 12V batteries and automatically switch to charge mode to complete the testing/charging function in less than 30 minutes. The XTC-160 offers two (2) options for charging; fast charge (approx. 40 minutes) up to 80% of capacity charge and full charge (approx. 40 minutes) up to 100% of capacity charge.

XTC-160

- Clear/easy menu system enables novice users mistake free operation
- Equipped with built in battery temperature sensor to safely maximize battery charge output and to shut down charging if battery temp increases to quickly
- Time calculator displays charge time remaining
- Patented smart clamps with built-in side post battery connectors
- 80 amp maximum output current charge
- USB port allows test data to be saved into an Excel format

Battery Voltage: 6V & 12V
Battery Range: 100-1600 CCA
Battery Type: Flooded and AGM
Automated Load: Up to 150 Amp Max
Operational Temp: 0-120°F
Language: English & Spanish
Dimensions: 11.5" x 11" x 9.25"
Cooling: 5" Fan



NEW!



Bus Chargers

The BusPro series chargers are completely automatic buss chargers with advanced circuitry that enables independent station charging in sets of three (3) or six (6) stations. These chargers utilize individual transformers and microprocessors for both low and high volume battery charging applications. Each channel works independently to charge the battery correctly and in a timely manner. Micro controlled digital pulse load helps to remove sulfation and prevent overcharging of batteries.

- Optimized smart models that are overcharge sensitive specifically for AGM batteries includes BusPro-360, BusPro-361, BusPro-660 and BusPro-662
- Stations can be doubled up to increase charge current (5 to 10 amps /10 to 20 amps)
- Each unit features two (2) LED lights per channel that indicate connections, charge status or error codes
- Includes heavy duty wall mount brackets and 72" lead
- 5 Amp or 10 Amp DC output
- 120V or 220V AC input

BusPro 360

Battery Voltage: 12V
Battery Type: Flooded and AGM
Charge Stations: 3
Automated Load: 5 Amp
Maintenance Load: 0 - 2.5 Amp
Operational Temp: 0-120°F
Language: English
Dimensions: 14" x 8" x 3.25"
Input Voltage: 110V AC



NEW!

BusPro 361

Battery Voltage: 12V
Battery Type: Flooded and AGM
Charge Stations: 3
Automated Load: 10 Amp
Maintenance Load: 0 - 5 Amp
Operational Temp: 0-120°F
Language: English
Dimensions: 26" x 8" x 3.25"
Input Voltage: 110V AC



NEW!

BusPro 600S

Battery Voltage: 12V
Battery Type: Flooded
Charge Stations: 6
Automated Load: 5 Amp
Maintenance Load: 0 - 2.5 Amp
Operational Temp: 0-120°F
Language: English
Dimensions: 26" x 8" x 3.25"
Input Voltage: 110V AC



NEW!

BusPro 620S

Battery Voltage: 12V
Battery Type: Flooded
Charge Stations: 6
Automated Load: 5 Amp
Maintenance Load: 0 - 2.5 Amp
Operational Temp: 0-120°F
Language: English
Dimensions: 26" x 8" x 3.25"
Input Voltage: 2.5A - 220V AC



NEW!

BusPro 660

Battery Voltage: 12V
 Automated Load: 5 Amp
 Maintenance Load: 0 - 2.5 Amp
 Operational Temp: 0-120°F
 Language: English
 Dimensions: 26" x 8" x 3.25"
 Input Voltage: 110V AC



NEW!

BusPro 662

Battery Voltage: 12V
 Automated Load: 5 Amp
 Maintenance Load: 0 - 2.5 Amp
 Operational Temp: 0-120°F
 Language: English
 Dimensions: 26" x 8" x 3.25"
 Input Voltage: 220V AC



NEW!



Accessories

The infrared external printer is for use with all AutoMeter handheld testers. Printer uses standard 58mm thermal paper and includes DC cigarette lighter and AC power adapter. Printer dimensions are 6" x 4.5" x 3.5"



Infrared Printer



Test Leads



PC cord



Carrying Case

Description	Options	Part No.
Infrared printer	Can be used with all models/testers shown above	PR-12
PC cord	Attach to your PC to print through your printer/all models	303135
Carrying case	Blow-molded case holds printer and any tester model	303130
Test leads	Replacement (all models)	303136

Digital and Analog Battery Testers

12-Volt Digital Battery Resistance Tester

- Fast – test results in seconds
- Safe – no heat, no sparks, no load
- Accurate digital readouts, no mistakes
- Compact – easy to use, handle and store
- Friendly – international multi-rating system: SAE, DIN, ENC2
- Flexible – on or off vehicle testing
- Automatic shut off for extended battery life
- Saves time – tests discharged batteries down to 9 volts; no need to charge before testing



Description	Part No.
12V digital battery resistance tester	303101

Analog Battery Load Tester

- Pre-set load
- 100-amp (12V) and 50-amp (6V) rating
- Voltmeter for state of charge, cranking, charging and starter tests
- Ideal for automotive, marine, motorcycle, RV



Description	Part No.
Analog battery load tester	303103

Analog Battery Load Analyzer

- Variable load with carbon pile
- 500-amp (12V) rating
- Large easy-to-read voltmeter for cranking, charging, and starter tests
- Auto Meter for load, alternator/regulator tests
- Heavy duty color-coded clamps
- Built in 15-second warning buzzer
- Ideal for professional use, fleet, agricultural, diesel and truck



Description	Part No.
Analog battery load analyzer	303104

Notes:

POWER PACKS

iStart® Li-ion 129
LifePO4® 130
Rescue® Power Packs 131-134
Rescue® Power Pack Accessories 135



Power Packs

Portable Power Packs. Engineered Better.

RESCUE[®] Portable Power Packs

- Engineered for the professional technician
- Designed for everyday use
- Unique Safety Features and Accessories
- Heavy duty and rugged construction

iStart[®]

Li-Ion Power Pack

- Consumer economical portable power and jump starting capability









iStart Li-Lon - Part No. 604039

-  Voltage: 5V, 9V, 12V
-  Cable Length: Red 9in (22cm), Black 6in (15cm)
-  Cable Gauge: 10 GA
-  Lithium Battery Type/Size: 44.4 Watt Hour 12,000 Milliamp Hour
-  Crank/Peak: 200/400 Amps
-  Charger: AC/DC Adaptor: 1A @ 14V, DC Power Socket: 1A @ 12V
-  Accessories/Features: Smart Safety Clamp Assembly, USB Port: 2A @ 5VDC, Port: 10A @ 12VDC, Port: 3.5A @ 19VDC, White SOS/Strobe/Work Light, Multi-cell Phone & PIN Adaptors, Soft Vinyl Case



NEW!

iStart 700 - Part No. 604049

-  Voltage: 12V
-  Cable Length: 22in (55.8cm)
-  Cable Gauge: 8 GA
-  Sealed Lead Acid Battery Type/Size: 9 Amp Hour
-  Crank/Peak: 250/500 Amps
-  Charger: 0.5 Amp Internal Battery Only
-  Accessories/Features: 12V Outlet Polarity Alarm, Flashlight



LiFePO4 200 - Part No. 604300

Voltage: 5V & 12V

Cable Length: 12in (30.5cm)

Cable Gauge: 8 GA

Lithium Battery Type/Size: 34 Watt Hour/10,400

Millamp Hour

Crank/Peak: 200/400 Amps

Charger: 2 Amp Micro USB Cord with 12V Power

Socket Adaptor & 2A @ 5V AC/DC Adaptor

Accessories/Features: Microprocessor Controlled Safety, Dual USB Port: 2.4A @ 5VDC, Battery Alternator Tester, White Flash/Work Light, Hard Plastic Case



NEW!

LiFePO4 400 - Part No. 604022

Voltage: 5V, 12V & 19V

Cable Length: 12in (30.5cm)

Cable Gauge: 8 GA

Lithium Battery Type/Size: 58 Watt Hour/18,000

Millamp Hour

Crank/Peak: 400/600 Amps

Charger: 2 Amp Micro USB Cord with 12V Power

Socket Adaptor & 2A @ 5V AC/DC Adaptor

Accessories/Features: Microprocessor Controlled Safety, Dual USB Port: 2.4A @ 5VDC, USB Port: 6A @

12VDC, Port: 3.5A @ 19VDC. Battery Alternator Tester,

Red Flash/White Work Light, 12V Power Outlet Cord

Pin Adaptors, Hard Plastic Case



NEW!

LiFePO4 800 - Part No. 604301

Voltage: 5V & 12V

Cable Length: 20in (50.8)

Cable Gauge: 4 GA

Lithium Battery Type/Size: 99.8 Watt Hour/32,000

Millamp Hour

Crank/Peak: 800/1600 Amps

Charger: AC/DC Charger: 1A @ 14, VDC, Power Socket:

1A @ 12VDC, External Battery: 1A @ 14.4VDC

Accessories/Features: Microprocessor Controlled

Safety, Dual USB Ports: 2.4A @ 5VDC, Battery/







Alternator Tester, Battery Maintainer, White Flash/

Work Light, Hard Plastic Case



NEW!









900 - Part No. 604050

-  Voltage: 12V
-  Cable Length: 27in (68.5cm)
-  Cable Gauge: 6 GA
-  Sealed Lead Acid Battery Type/Size: 18 Amp Hour
-  Crank/Peak: 400/900 Amps
-  Charger: 1 Amp Internal Battery Only
-  Accessories/Features: 12V Outlet Polarity Alarm



910 - Part No. 604083







Requires distributor installed battery

-  Voltage: 12V
-  Cable Length: 27in (68.5cm)
-  Cable Gauge: 6 GA
-  Battery Type/Size: 18, 20 or 22 Amp Hour (Not Included)
-  Charger: 1 AMP Internal Battery Only
-  Crank/Peak: Dependent on battery size.
-  Recommended battery size 7-1/16" width x 3" deep x 6-9/16" height
-  Accessories/Features: 12V Outlet Polarity Alarm









Battery not included

950 - Part No. 604051

-  Voltage: 12V
-  Cable Length: 55in (139.7cm)
-  Cable Gauge: 6 GA
-  Battery Type/Size: 18 Amp Hour
-  Crank/Peak: 400/900 Amps
-  Charger: 1 Amp Internal Battery Only
-  Accessories/Features: 12V Outlet Polarity Alarm, Flashing/Work Light, Compressor 0.45 CFM @ 120 PSI 10 min. Duty Cycle



1060 - Part No. 604084

-  Voltage: 12V
-  Cable Length: 55in (139.7cm)
-  Cable Gauge: 6 GA
-  Battery Type/Size: 20 Amp Hour
-  Crank/Peak: 400/900 Amps
-  Charger: 1 Amp Internal Battery Only
-  Accessories/Features: 12V Outlet Polarity Alarm, Flashing/Work Light, Compressor 0.45 CFM @ 120 PSI 10 min. Duty Cycle, 300W Inverter, USB Port



1220 Aero - Part No. 604082

For accessories see the following section: Rescue Power Pack Accessories



Voltage: 12V

Cable Length: 62in (157.5cm)

Cable Gauge: 2 GA

Battery Type/Size: Dual 20 Amp Hour

Crank/Peak: 700/1500 Amps

Charger: 1 Amp Internal Battery Only

Accessories/Features: 12V Outlet Polarity Alarm, Flashing/Work Light, Aero Cable & USB Port



1800 - Part No. 604053



Voltage: 12V

Cable Length: 62in (157.5cm)

Cable Gauge: 2 GA



Battery Type/Size: Dual 20 Amp Hour

Crank/Peak: 700/1500 Amps



Charger: 1 Amp Internal Battery Only

Accessories/Features: 12V Outlet Polarity Alarm, Work Light



2100 - Part No. 604063



Voltage: 12V & 24V

Cable Length: 62in (157.5cm)



Cable Gauge: 2 GA



Battery Type/Size: Dual 22 Amp Hour

Crank/Peak: 12V 900/1600 Amps 24V 500/1100 Amps



Charger: 1 Amp Internal Battery Only



Accessories/Features: 12V Outlet Polarity Alarm, Voltage Protection, Flashing/Work Light, USB Port



3000 - Part No. 604055

Requires distributor installed battery



Voltage: 12V

Cable Length: 55in (139.7cm)



Cable Gauge: 4 GA



Battery Type/Size: One Group U1 Sealed (Not Included)



Crank/Peak: Based on battery size



Charger: 1 AMP Internal Battery Only

Accessories/Features: 12V Outlet Polarity Alarm, Flashing/Work Light



Battery not included

4000/4000 HD - Part No. 604100/604105

Requires distributor installed battery



Voltage: 12V

Cable Length: 42in (105.5cm)

Cable Gauge: 4000 2 GA/4000HD 1/0 GA



Battery Type/Size: 4000: One GR. 24 Sealed (Not Included)/4000HD: TWO GR. 51 Sealed (Not Included)



Crank/Peak: Dependent on battery size.

Charger: 7 Amp Internal/External Battery Charger

Accessories/Features: Two 12V Outlets, Polarity Alarm



Battery not included

4050/4050 HD - Part No. 604101/604106

Requires distributor installed battery



Voltage: 12V

Cable Length: 42in (105.5cm)

Cable Gauge: 4050 2 GA/4050HD 1/0 GA



Battery Type/Size: 4050: One GR. 24 Sealed (Not Included)/4050HD: TWO GR. 51 Sealed (Not Included)



Crank/Peak: Dependent on battery size.

Charger: 7 Amp Internal/External Battery Charger

Accessories/Features: Two 12V Outlets, Polarity Alarm, Compressor: 0.9 CFM @ 60 PSI 20 Min. Duty Cycle



Battery not included

5000 - Part No. 604110

Requires distributor installed battery



Voltage: 12V & 24V

Cable Length: 10ft (3.04m)

Cable Gauge: 1/0 GA



Battery Type/Size: Two Group 31 Sealed (Not Included) Crank/Peak: Dependent on battery size.



Charger: 8 Amp Internal Battery Only

Accessories/Features: -



Battery not included

5020 Aero - Part No. 604115

Requires distributor installed battery



Voltage: 12V & 24V

Cable Length: 10ft (3.04m)

Cable Gauge: 1/0 GA



Battery Type/Size: Two Group 31 Sealed (Not Included) Crank/Peak: Dependent on battery size.

Charger: 8 Amp Internal Battery Only

Accessories/Features: 175 Amp Auxiliary Connection



Battery not included

6000 - Part No. 604120

Requires distributor installed battery



Voltage: 12V & 24V



Cable Length: 10ft (3.04m)

Cable Gauge: Twin 1/0 GA (4/0 Equivalent)



Battery Type/Size: Two Group 31 Sealed (Not Included)

Crank/Peak: Dependent on battery size.

Charger: 8 Amp Internal Battery Only

Accessories/Features: 350 Amp Auxiliary Connection



Battery not included



RESCUE® Power Pack Accessories

ECM/ECU/PCM Memory Saver Cable OBD II

- Use your Rescue Portable Power Pack to prevent ECM memory loss when the vehicle's battery is disconnected
- In-line fuse
- Easily stored in tool box
- 59" long



Description	Part No.
OBD II with 12-volt male plug	604089

ECM/ECU/PCM Memory Saver Cable Pre-OBD II

- Use your Rescue Portable Power Pack to prevent ECM memory loss when the vehicle's battery is disconnected
- In-line fuse
- Easily stored in tool box
- 59" long



Description	Part No.
12-volt DC male-to-male cord	604061

Aero Connection Kit for Rescue® Model 1220

- Designed to jumpstart aircraft and ground support vehicles
- Plug-in cables available with Cessna® or 12-volt polarized style plug-ins
- Model 5020 requires 602570 cable to provide reach for connecting cables 602563 and 602562



602560



602562



602563

Description	Part No.
Plug-to-plug extension, 2 GA copper, 144" (3.6m)	602560
12-volt polarized style coupling cable, 2 GA copper, reach 40" (2.29m)	602562
Cessna-style coupling cable, 2 GA copper, reach 40" (2.29m)	602563
Battery clamp cable, 2 GA copper, reach 62" (1.57m)	602564

In-Cab Charging Cord

- Using your vehicle's cigarette lighter, current limiter protects vehicle circuits from overload while fully charging your power pack
- Specially engineered for emergency road service vehicles
- LED indicator shows current is available
- Maintain a full charge on heavily-used Power Packs
- Convenient 10' cord - color-coded for input/output
- Works with all Rescue® Portable Power Packs



Description	Part No.
In-cab charging cord	604095

SAFETY & CHEMICALS

- Battery Recycling 137
- Battery Leaker Kit..... 137
- Battery Washers..... 137
- Battery Corrosion Preventatives 138
- Battery Terminal Protection Kit..... 139
- Plastic & Glass Cleaner 139
- Battery Cleaner 139
- Black Battery Reconditioner Paint 139
- Battery Terminal Wipes.....140
- Automotive Battery Cleaner140
- Industrial Battery Cleaner.....140
- Battery Wash Watch Treatment140
- Stationary Battery Wipedown.....141
- Stationary Battery Wipes 141
- Battery Maintenance Kits..... 141
- Resuce® Battery Acid Spill Solutions..... 142
- Rescue® Battery Acid Spill Kits.....143
- Acid Absorbent Pillows & Socks144
- Battery Rack144
- Quick Battery Rack Enclosure 145
- Acid Containment Pallets145
- Pallet Strapping Kits145
- Rescue® Battery Acid Containment System ...146



Battery Recycling

Battery Disposal Bags

- Designed for the temporary storage of leaking or damaged batteries
- Clear gusseted heavy mil polybag with flat bottom
- Fits SLI and other batteries (see dimensions on drawing)
- Seal bag with included cable ties
- Sold in quantities of 10 or 50 (inquire for larger quantities)

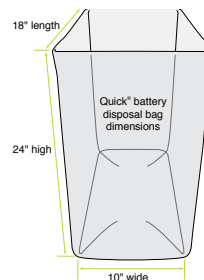

Description	Part No.
Battery disposal bag	510335

Battery Leaker Kit

- Patented construction with cut corner inner carton; 6 mil polybag with hermetic seal and outer carton with self-closing tab
- Comes fully assembled, ready to use
- Sized for Group 31 extra duty batteries and smaller
- Kit can be closed and sealed, without extra items such as tape, tools, etc.
- Can be opened for inspection and re-sealed without extra items such as tape



Description	Part No.
Battery Leaker Kit	510950

Battery Washers

- Battery washers seal out acid fumes protecting terminals from corrosion
- Washer is impregnated with a corrosion preventative
- Available in red and black for easy polarity identification
- A washer style for all your needs: Top Post, Side Terminal, Combo: Top and Side Terminal, Marine/Golf Cart Post
- Packaged in convenient plastic screw top jars, plastic bags and blister cards



Side Terminal Washer	Part No.
1 pair per bag	6621-2002
*50 pieces per jar – black	6621-050B
*50 pieces per jar – red	6621-050R
100 pieces per jar – black	6621-100B
100 pieces per jar – red	6621-100R
100 pcs. – 12 jars/case – black	6621-012B
100 pcs. – 12 jars/case – red	6621-012R

Combo Top/Side Washer	Part No.
1 pair per bag	6623-2002
*50 pieces per jar – black	6623-050B
*50 pieces per jar – red	6623-050R
100 pieces per jar – black	6623-100B
100 pieces per jar – red	6623-100R

Top Post Terminal Washer	Part No.
1 pair per bag	6622-2002
*50 pieces per jar – black	6622-050B
*50 pieces per jar – red	6622-050R
100 pieces per jar – black	6622-100B
100 pieces per jar – red	6622-100R
100 pcs. – 12 jars/case – black	6622-012B
100 pcs. – 12 jars/case – red	6622-012R

Marine/Golf Cart 3/8" Washer	Part No.
*100 pieces per jar – black	6626-100B
*100 pieces – 12 jars/case – black	6626-120B

Safety & Chemicals

Battery Corrosion Preventatives

- Seals out acid fumes, road salt, moisture and dirt

QuickCote+™ with Acid Neutralizer

- Brush-on compound seals out corrosion and neutralizes acid
- Non-hardening, non-cracking
- Use on all exposed electrical connectors, also prevents seizing of threaded fasteners
- 8 oz. can has brush applicator



Description	Part No.
1 can/8 oz. (240 g.) with applicator brush	6023
32 oz. (909 g.) economy can	6022

Original Red Aerosol Formula

- Sprays on red, showing presence of protective coating
- Does not dry out or evaporate
- Improved non-running, no-drip formula – use less per application
- Net weight 9.75 oz (276 grams) per can



Description	Type	Volume	Part No.
Red corrosion preventative	Aerosol	9.75 oz. (276 g.)	510400
	Pump spray	3/4 oz. (21 g.)	510146

Clear Silicone Sealant

- Clear silicone formula – QuickCable exclusive
- Seals out acid and water, formulated specifically for use on batteries
- Sprays on white, showing area of protection
- Does not dry out or evaporate
- Helps seal electrical connections and other wiring applications



Description	Type	Volume	Part No.
Clear corrosion preventative	Aerosol	9.75 oz. (276 g.)	510410

Protective and Cleaner Sprays

- Cleaner spray cleans terminals and connectors while neutralizing acid
- Protective spray protects exposed electrical connections from corrosion
- Both come as a compact sized container which easily fits in tool box or pocket



Description	Part No.
Battery protective spray – 3/4 oz. (28 g.)	120141
Battery cleaner spray – 1-1/8 oz. (32 g.)	120131

Battery Terminal Protection Kit

- Includes terminal protectors, battery cleaning brush, 3/4 oz. terminal protection spray, 1-1/8 oz. cleaner spray, hand cleaning towelette



Description	Part No.
Battery terminal protection kit	120145-2001

Plastic & Glass Cleaner

- All purpose plastic and glass cleaner
- Cleans and brightens new batteries for sale
- Safe for Plexiglas and tinted window film
- Net weight 18.75 oz. (532 g.)
- Not for sale in California



Description	Type	Volume	Part No.
Plastic and glass cleaner	Aerosol	18.75 oz. (532 g.)	510450

Battery Cleaner

- Foaming cleaning action
- Dissolves corrosion and neutralizes acid
- 510430 has color change formula that turns red when acid is present and back to yellow when acid is neutralized
- Cleaner spray, 1 oz pump, tool box/pocket size



Description	Type	Volume	Part No.
Battery cleaner	Aerosol	13.75 oz. (390 g.)	510420
Battery cleaner with acid detector			510430
Battery cleaner and acid neutralizer	Pump spray	1 oz. (28 g.)	510145

Black Battery Reconditioner Paint

- Restores battery to original look
- Fast drying and formulated to adhere to battery plastics and metal
- Fan spray nozzle for uniform coverage
- Other uses include battery hold-downs, trays, cases and other areas needing a coat of paint



Description	Type	Volume	Part No.
Battery reconditioner	Aerosol	12 oz. (340 g.)	510420

Battery Terminal Wipes

- 30 handy, disposable wipes per container
- Cleans terminals and neutralizes acid
- The blue wipe turns red when exposed to acid and back to blue when the acid is neutralized
- Each wipe is 7" x 8"



Description	Part No.
Battery terminal wipes	510148

Automotive Battery Cleaner

- Color change formula turns bright red when acid is present and back to yellow when acid is neutralized
- Cleans batteries in cars, boats, RVs
- Turns red in the presence of battery acid
- Neutralizes acid and returns to light yellow color
- Net contents: 1 quart (.95 L)



Description	Part No.
Automotive battery cleaner	510156
Additional sprayer for 32 oz. bottle	510346

Industrial Battery Cleaner

- Cleans batteries, neutralizes acid
- Excellent for dissolving corrosion and neutralizing acid
- Economical refills



Description	Part No.
Industrial battery cleaner – 35 gallon	510140-035
Industrial battery cleaner – 5 gallon	510140-005
Industrial battery cleaner – 12 quarts	510145-012
Industrial battery cleaner – 4 quarts	510145-004
Industrial battery cleaner – 1 quart	510145-001

Battery Wash Water Treatment

- Use to adjust the pH in wash water
- Non-corrosive and non-hazardous
- Allows for reuse of wash water
- Can also be used to remove acid from concrete floors in preparation for epoxy floor paint or containment system
- Use to clean acid contaminated floor and equipment such as battery racks and delivery vehicles



Description	Part No.
Washwater treatment – 35 gallon container	510160-035
Washwater treatment – 5 gallon container	510160-005
Washwater treatment – 1 gallon container	510160-001
Washwater treatment – 4 gallon case	510160-004

Stationary Battery Wipedown

- Safe for use on all battery plastics including stationary and UPS
- Turns bright red in the presence of battery acid
- Neutralizes acid and returns to light yellow color
- Formula complies with IEEE requirements
- Net contents: 1 quart (.95 L)



Description	Part No.
Stationary battery wipedown	510142

Stationary Battery Wipes

- 30 handy, disposable wipes per container
- Safe for use on all battery plastics including stationary and UPS
- Turns bright red in the presence of battery acid
- Neutralizes acid and returns to light yellow color
- Formula complies with IEEE requirements
- Each wipe 7" x 8"



Description	Part No.
Stationary battery wipes	510147

Battery Maintenance Kits

- Kits for top post, side terminal and Group 31 stud batteries
- Complete with cleaner, protective spray, washers and brush
- Carry case (6-pack style) has extra space for additional tools such as safety glasses, pliers etc.
- Complete convenient kits for battery installers and maintenance technicians
- Designed for the battery professional but also great for DIY customers



Battery Type	Spray Color	Kit Contents	Part No.
Top post and side terminal	Clear silicone	1 – battery cleaner 1 – battery corrosion preventative 50 – combination battery washers 1 – terminal cleaning brush 1 – carry case (6-pack style)	510900
Top post and side terminal	Red	1 – battery cleaner 1 – battery corrosion preventative 50 – combination battery washers 1 – terminal cleaning brush 1 – carry case (6-pack style)	510901
Group-31 stud terminal	Red	1 – battery cleaner 1 – battery corrosion preventative 50 – stud battery washers 1 – terminal cleaning brush 1 – carry case (6-pack style)	510902

Rescue® Battery Acid Spill Solutions

Acid Spill Absorber & Neutralizer

- Turns bright red in the presence of battery acid
- Neutralizes acid and returns to light yellow color
- Twice as absorbent as clay-based but only half the weight
- Use in acid drip pans
- Safe and non-hazardous
- Not dusty like clay
- Instructions and SDS included
- Durable easy to store container with re-sealable lid
- See OSHA 1926.441 and 1910.173



Description	Part No.
Rescue acid absorber – 1 lb. jar	510130-000
Rescue acid absorber – 8 lb. jug	510130-001
Rescue acid absorber – 25 lb. pail	510130-005
Rescue acid absorber – 160 lb. drum	510130-030

Absorption Quantities
1 lb. (.45 kg.) absorbs 1 quart (.95 L)
8 lb. (3.6 kg.) absorbs 2 gallons (7.57 L)
25 lb. (11.3 kg.) absorbs 6 gallons (22.7 L)
60 lb. (27.3 kg.) absorbs 15 gallons (56.78 L)

EZ-Zorber

- Acid absorber and neutralizer
- Dry formula
- Absorbs and neutralizes battery acid spills
- Economical and easy-to-use
- Approximately 20 lb. (2.5 gallon)



Description	Part No.
EZ-Zorber acid absorber	510135-002

Battery Acid Floor & Counter Mat

- Mat absorbs acid but won't leak through tough polypropylene backing
- Absorbs 6 oz of acid per square foot
- Cut to size for battery compartments, storage racks or drip pans
- Use on floor or under the battery
- Protects workbench or retail counter from abrasion and acid corrosion
- Use Wash Water Neutralizer to neutralize acid



Description	Part No.
36" wide floor and counter mat (50' roll)	510170-050
36" wide floor and counter mat (25' roll)	510170-025
36" wide floor and counter mat (10' roll)	510170-010
72" wide floor and counter mat (25' roll)	510171-025
72" wide floor and counter mat (8' roll)	510171-008

RESCUE® Battery Acid Spill Kits

- Five kits: 1/2-gallon, 2-gallon, 6-gallon, 15-gallon and 25-gallon
- Kits come with acid absorber and neutralizer as well as safety wear, brush, pan, disposal bags and SDS
- Red to yellow color change shows when acid is neutralized and safe
- Twice as absorbent as clay but only half the weight
- Use in acid drip pans
- Safe and non-hazardous
- Not dusty like clay absorbers
- Acid neutralizer is available from 1 lbs. to 160 lbs. containers



<p>510192 2-Gallon Spill Kit</p> 	<p>Neutralizes 2 gallons/7.57 liters</p> <ul style="list-style-type: none"> • 8 lbs./3.6 kg. acid absorber and neutralizer • 1 pair nitrile acid-proof gloves • 1 pair safety glasses • 2 disposal bags • 1 pair paddles 	<p>510195 1/2-Gallon Spill Kit</p> 	<p>Neutralizes 1/2 gallon/1.89 liters</p> <ul style="list-style-type: none"> • 2 jars (16 oz./453 gr.) acid absorber and neutralizer • Eye and skin wash solution • 5 gusseted battery bags, 10" x 18" x 24" • 1 pair lined nitrile gloves (XL) • Safety goggles • Brush and pan (2 piece kit) • 10 yellow Hazmat pads, 19" x 15" • Gr. 65, scissors battery carrier • Yellow storage box
<p>510191 6-Gallon Spill Kit</p> 	<p>Neutralizes 6 gallons/22.7 liters</p> <ul style="list-style-type: none"> • 25 lbs./11.3 kg. acid absorber and neutralizer • Safety wear for 1 (shoe covers, gloves, goggles, apron) • Brush and pan (2 piece kit) • Plastic disposal bag 	<p>510198 25-Gallon Spill Kit</p> 	<p>Helps contain and neutralize up to 25 gallons/94.6 liters of acid</p> <ul style="list-style-type: none"> • 100 lbs./45 kg. acid spill absorber and neutralizer • Broom head • Broom handle • 12 absorbent socks, 3" x 48" • 5 pillows, 12" x 12" • 50 yellow Hazmat pads, 19" x 15" • 4 black disposal poly bags • 2 nitrile aprons • 2 pair rubber boot covers (XL) • Safety goggles (2) • 2 pair face shields & head gear • 2 pair lined nitrile gloves • 10 gusseted battery bags, 10" x 18" x 24" • Non-sparking, folding shovel • Yellow rolling container
<p>510190 15-Gallon Spill Kit</p> 	<p>Neutralizes 15 gallons/56.7 liters</p> <ul style="list-style-type: none"> • 60 lbs./27.3 kg. acid absorber and neutralizer • Safety wear for 2 (shoe covers, gloves, goggles, apron) • Brush and pan (2 piece kit) • Plastic disposal bag • Broom • Hazmat drum 		

Acid Absorbent Pillows & Socks

- Pillows and socks are made from heavy duty, white polypropylene fabric
- The fabric absorbs acid quickly, reducing uncontrolled run-off; at the same time, it is dense with minimal dusting
- Tested against the federal standard FMVSS 302, 49 CFR Ch V (10-1-03 Edition, page 761), the fabric is self-extinguishing
- The acid indicator in pillows and socks will "show" pink or red indicating the presence of battery acid
- A label sewn on each pillow and sock lists cautionary and performance information, as well as part number and date of manufacture
- Use with containment system or separately for reliable acid capture and neutralization
- Ideal to use as dam to contain acid spill or surround a leaking battery
- A granular absorbent material quickly absorbs and neutralizes a minimum of 4 quarts (3.8 liters) of battery acid (sulfuric acid, also known as battery electrolyte)
- Safe and non-hazardous
- Safety Data Sheet (SDS) available online at quickcable.com or by contacting QuickCable



Description	Part No.
Absorbent pillow, 12" x 12" (30 x 30 cm)	217130
Absorbent sock, 3" x 48" (7.5 x 120 cm)	217135

Battery Rack

- For uninterruptible power supply, switchgear, telecommunications and utility battery applications
- Designed for popular batteries used in stored electrical energy such as L16, GC2, T105, Group 27, Group 31 and equivalent
- Sturdy steel construction, polyurethane powder-coated to reduce rust and corrosion
- Modular design allows for back-to-back or side-to-side expansion

Seismic Kit

- Accommodates various battery sizes
- Designed to retain batteries in rack during seismic event

Description	Part No.
Seismic kit	990221

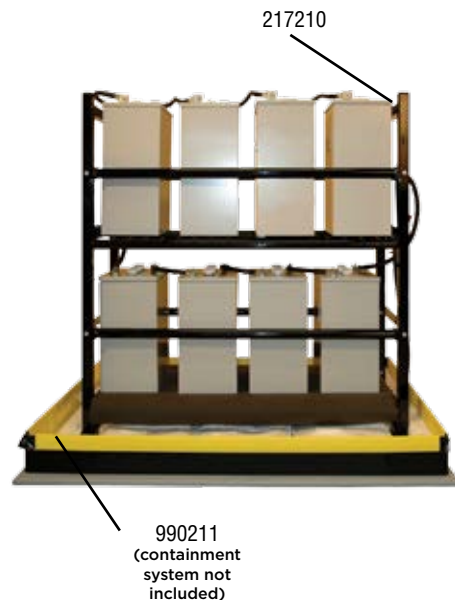

Rack Part No.	Description	Battery Group	Batteries/ Shelf	Inside Dimensions (Space for Batteries)			Outside Dimensions (Footprint)			Shipping Weight	Containment System Kit
				Length	Width	Height	Length	Width	Height		
990211	Two fixed shelves	L16, GC2, T105, Group 22, 24, 27, 31	8/rack 4/shelf	14" (36 CM)	36" (92 CM)	19-1/4" (49 CM)	17-1/2" (43.7 CM)	38-1/2" (97.8 CM)	47-3/4" (121.4 CM)	70 lbs. (31.8 kg.)	217210

QUICK® Battery Rack Enclosure

- Simple access to upper and lower shelf of rack for maintenance of batteries
- Reduces chance of injury or damage due to incidental contact with electrical connections

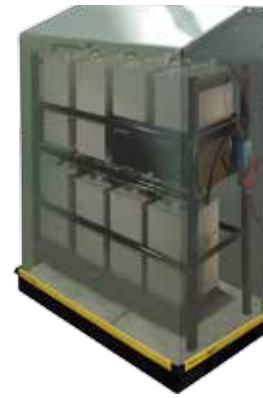

Battery's not included

Description	Part No.
Enclosure for rack no. 990211 (two fixed shelves, eight/rack)	990190

Acid Containment Pallets

8000 Pounds

- Holds up to 66 gallons of battery acid/liquid
- Will support up to 8000 pounds
- Resists corrosion, moisture and battery acid
- Made of polyethylene
- 52" x 52" x 8" (132 x 132 x 19 cm)
- Has drain plug



Description	Part No.
8000 lb. pallet	510251

Pallet Strapping Kits

- Ideal for strapping batteries together and to pallets
- Corded polyester strap is stronger and lighter than steel
- Strap is acid-resistant, non-conductive, non-corrosive and weatherproof
- Safer than steel, no snap back, no sharp edges and easier to dispose of
- Fast and simple - one tool tensions and cuts
- Two strapping kits, both include strapping and steel buckles



420581



420590



420580

Description	Part No.	420590 Dispenser Box Kit	420580 Wheeled Cart Kit
Strap tensiometer and cutting tool	420581	1 each	1 each
Strap buckles 2000 lbs. capacity	420582	200 each	200 each
Strap poly	420583	700'	2000'
Portable dispenser toolbox	420591	1 each	-
Pallet reach under needle	420584	-	-
Rolling strap dispenser and tray	420585	-	1 each

RESCUE® Battery Acid Containment System

- Complete turnkey kits include rails, pre-made corners, liner, liner clips, pillows and socks appropriate for your installation, masonry drill bit, fasteners, silicone caulk and leak detecting spray with color indicator (for specifications, see components listing)
- Two rail systems available - PVC or stainless steel, depending on your specifications and code requirements
- Designed for UPS, switchgear, telecommunication, and utility battery cabinets and relay racks
- Ideal for wet lead-acid batteries, VRLA batteries, battery cabinets and relay racks
- Complies with Uniform Fire Code (UFC) article 64, section 104.d and 104.e, OSHA and EPA regulations
- Illustrated instructions included with each kit; instructional video available online at quickhowto.com
- Components available separately
- Available as private label

PVC Liner

- Black 12 mil PVC, acid-proof
- Flammability rating of VTM-O, oxygen index of 28+
- Two sizes 48" (122 cm) and 60" (152 cm) wide, sold by the linear foot

Liner Clip

- Made of safety yellow PVC
- Clip snaps into place on PVC or stainless steel rails
- Clips hold liner in place

Containment System for QuickCable® Battery Rack

Length		Width		PVC System Kit	Stainless Steel System Kit	Fits Battery Rack
Inches	Cent.	Inches	Cent.			
44	112	24	61	217210	217230	990211

Stainless Steel Rails and Corners

- Interlocking rails and corners
- Made from 20 GA stainless steel
- Rails are 4" high x 2" wide x 46" long (10 x 5 x 116 cm), custom lengths available
- Rails formed so clips snap into place to secure liner
- Rails are pre-drilled for easy installation
- Corners are pre-made 5" (12 cm) long

PVC Rails and Corners

- Made of black flame retardant PVC
- Rails are 4" high, 2" wide and 60" long (10 x 5 x 152 cm)
- Corners are pre-made 6" long with 4" sides (15 x 10 cm)
- Floor rail is grooved for easy start of fasteners
- Rails have recess, so clips snap into place securing liner

Description	Part No.
PVC corner	217101
PVC rail 60" (152 cm) long	217102
Stainless steel corner	217191
Stainless steel rail 46" (116 cm) long	217192
PVC liner clip 60" (152 cm) long for all rails	217110
PVC liner 48" (122 cm) wide	217120
PVC liner 60" (152 cm) wide	217121



Custom Sizing Available –

Visit http://www.quickcable.com/containment_configuration for containment system configurator

KITS

Cable Maintaining Kits..... 149-150
Field Repair and Garage Kits 150-151
Connector Kits..... 151-153
Route Service Connector Kits..... 154-155



Cable Maintaining Kits

- These kits make it easy and profitable to build repair/replacements for vehicles and equipment
- Terminal crimper, cable cutter, cable stripper, heat gun
- Popular terminal sizes and styles
- Terminal protectors and heat shrink
- Battery cable
- Organizing drawer

1 GA, 4 GA & 2/0 GA Vehicle Starter Kits

- For lawn and garden, automotive, marine, agricultural and commercial applications

Description		Part No.
<ul style="list-style-type: none"> • Quick® Crimp 250 – hand-held style • Heat gun <p>131 pcs. terminal assortment:</p> <ul style="list-style-type: none"> • Ten 1 GA str. cla. (neg. & pos.) • Ten 4 GA str. cla. (neg. & pos.) • Twenty 2/0 GA str. cla. (neg. & pos.) • Eight 2/0 GA flag cla. (neg. & pos.) • Ten 1 GA 3/8" lugs • Ten 4 GA 3/8" lugs • Ten 2/0 GA 3/8" lugs 	<ul style="list-style-type: none"> • Cable stripper • 25' 4 GA cable • 25' 1 GA. cable • 25' 2/0 GA cable <p>9" cutter</p> <ul style="list-style-type: none"> • 24 compartment parts drawer 	9999
Same kit as above but with Quick Crimp 250 – bench mount style tool.		9995



Kit 9995 comes with bench mount tool

2/0 GA Heavy Duty Starter Kits

- Heavy-duty cables for truck, agricultural and commercial applications



Kit 9994 comes with bench mount tool

Description		Part No.
<p>Kit includes:</p> <ul style="list-style-type: none"> • Quick® Crimp 250 – hand-held style • Heat gun • 9" cutter <p>143 pcs. terminal assortment:</p> <ul style="list-style-type: none"> • Eight 2/0 GA flag cla. (neg. & pos.) • Four 2/0 GA stud flag clamps • Ten 2/0 GA HD lugs, 3/8" • Five 2/0 GA HD lugs 1/2" • Ten 2/0 GA locking lugs 3/8" • Five 2/0 GA locking lugs, 1/2" • Twenty 2/0 GA str. cla. (neg. & pos.) • Twenty 3/4" blk., ht.-sh. pcs. 1-1/2" • Twenty 3/4" red, ht.-sh. pcs. 1-1/2" • Five str., 1/0 & 2/0 GA term. prot., blk. 	<ul style="list-style-type: none"> • 24 compartment parts drawer • Cable stripper • 25' 2/0 GA cable 	9998
Same kit as above but with Quick Crimp 250 – bench mount style tool.		9994

4 GA & 1 GA Medium and Light Duty Starter Kits

- Includes 4 and 2 GA cable and connectors for automotive, marine, lawn and garden applications



Kit 9993 comes with bench mount tool

Description	Part No.
<p>Kit includes:</p> <ul style="list-style-type: none"> • Quick® Crimp100 – hand-held style • Heat gun • 9" cutter • 24 compartment parts drawer • Cable stripper • 25' 4 GA cable • 25' 2 GA cable <p>176 pcs. terminal assortment:</p> <ul style="list-style-type: none"> • Ten 2 GA HD lugs 3/8" • Ten 4 GA HD lugs 3/8" • Five 2 GA lock. lugs 3/8" • Five 4 GA lock. lugs 3/8" • Twenty 2 GA straight clamps (neg. & pos.) • Twenty 4 GA straight clamps (neg. & pos.) • Five 2 GA HD lugs, 1/2" • Five 4 GA HD lugs, 1/2" • Ten 4 GA 3/8" copper lugs 45° bend • Ten 2 GA 5/16" copper lugs 45° bend • Ten 3/4" blk., heat-shrink pcs. 1-1/2" • Ten 3/4" red, heat-shrink pcs. 1-1/2" • Four straight, 4 GA terminal protectors, blk. • Four straight, 4 GA terminal protectors, red • Four straight, 1 & 2 GA terminal protectors, blk. • Four straight, 1 & 2 GA terminal protectors, red • Ten 4 GA 5/16" copper MAX™ lugs • Ten 4 GA 3/8" MAX™ lugs • Ten 2 GA 5/16" MAX™ lugs • Ten 2 GA 3/8" MAX™ lugs • Forty 5/16"-18 x 1-1/4" square head bolts and shoulder nuts 	9947
<p>Same kit as above but with Quick Crimp 250 – bench mount style tool</p>	9993

Field Repair and Garage Kits

- Contains all tools and materials necessary to repair cables

2/0 GA Heavy Duty Field Repair Kits



9921 kit

Description	Part No.
<p>Kit includes:</p> <ul style="list-style-type: none"> • Carrying case • 9" cutter • 2/0 straight clamp – positive and negative • 2/0 flag clamp – positive and negative • 2/0 starter/gr. lug – 3/8" and 1/2" hole • 3/4" heat-shrink tube – black and red 6" • Terminal protector straight – black and red • Terminal protector flag – black and red • Square head bolts and shoulder nuts 	9920
<p>Kit includes: Same as above kit but also includes a Quick® Crimp 250</p>	9921

4 GA and 2 GA Medium/Light Duty Field Repair Kit



Description	Part No.
Kit includes: <ul style="list-style-type: none"> • Carrying case • 9" cutter • QuickStrip cable stripper • Quick® Crimp 100 crimping tool 	<ul style="list-style-type: none"> • 4 straight clamp – positive and negative • 4 and 2 GA copper tube lug – 3/8" hole • Square head bolts and shoulder nuts
	9957

6 GA, 4 GA and 2 GA Garage Maintenance Kit



Description	Part No.
Kit includes: <ul style="list-style-type: none"> • 130 pieces • Carrying case • 9" cutter • QuickStrip cable stripper • Quick® Crimp 100 crimping tool • Angle nose pliers • Sidebolt ratchet tool • Battery terminal lifter 	<ul style="list-style-type: none"> • Clamp spreader/reamer • Battery brush • QuickCote™ • 6, 4, 2 GA connectors • Heat-shrink, protective washers • Square head bolts and shoulder nuts • 6, 4, 2 GA cable • Side terminal bolts
	9967

Connector Kits

Heavy-Duty, Crimp Connector Kits

- Four different kits with components to build medium to heavy-duty cables, automotive and marine, and heavy-duty cables for a variety of applications
- Kits contain components needed to make OEM quality cables: connectors, heat-shrink tube, fasteners and terminal protectors
- 24-compartment, durable metal box with handle and latch fits into standard fastener racks



9902
kit



9908
kit

Fits GA	Kit Size	Part No.
1/0 GA	131 pieces	9902
4, 1, 2/0 GA	176 pieces	9908
4, 2 GA	171 pieces	9910
2/0 GA	171 pieces	9906

Kit contents are listed on our website: Go to www.quickcable.com then, search the part number you're looking for.

Die-Cast Copper Compression Connector Kits

- Make permanent repairs in the field without special tools
- Choose medium or heavy duty connector assortments of lugs and battery clamps
- Inside cover lists contents and part numbers for easy reorder and has complete illustrated assembly instructions



Fits GA	Kit Size	Part No.
1, 2 GA	130 pieces	9103
2/0 GA	120 pieces	9125

Kit contents are listed on our website: Go to www.quickcable.com then, search the part number you're looking for.

MagnaLugs® - Heavy Wall Copper Tube Lug Kits

- Three kits for light-to-medium, heavy duty and commercial/ industrial applications
- A variety of lugs, heat-shrink and butt splices are included



Fits GA	Kit Size	Part No.
4, 1 GA	104 pieces	9930
3/0 GA	87 pieces	9931
2/0 GA	87 pieces	9932

Kit contents are listed on our website: Go to www.quickcable.com then, search the part number you're looking for.

9930
kit

MAX™ Bare Copper and Tin-Plated Copper Lug Kit

- 100% seamless copper tube lugs
- UL and CUL approved
- Flared barrel end for easy assembly
- Convenient re-closable kit box
- Easy identification and reorder chart
- Kit contains popular 8 gauge thru 3/0
- Kit contains 1/4", 5/16", 3/8" & 1/2" stud hole sizes



NEW!

Pieces	Description	Part No.
76	Bare Copper Lug Assortment Kit	9105
	Tin-Plated Copper Lug Assortment Kit	9106

Kit contents are listed on our website: Go to www.quickcable.com then, search the part number you're looking for.

9105
kit

SB® Connectors Kits 175A and 350A Gray

- Kits include contacts, Anderson SB® housing connectors and heat-shrink so you can make cable connections as you need them
- Choose from copper crimp contacts, or copper Fusion® contacts with solder and flux preloaded — no crimping required



Fits GA	Kit Size	Part No.
4, 2, 1/0, 2/0 GA	Crimp 73 pieces	400801
2, 1/0, 2/0 GA	Fusion® 73 pieces	400802

Kit contents are listed on our website: Go to www.quickcable.com then, search the part number you're looking for.

400802
kit

6 GA to 4 GA Custom Golf Cart Cable Starter Kit

- Dealing with an unusual model with special order cables? No problem when you can fabricate what you need in-house – and pocket the extra profits
- Make the cables you need when you need them
- Kit includes everything you need – cable, tools, heat gun, terminals, protectors, heat-shrink tubing and hardware



Part No.	Description
205910	4 GA to 6 GA, custom starter kit for golf carts
Kit Contents	
25' roll – 6 GA black welding Cable	20 ea. – 5/16" x 18 shoulder nut
25' roll – 6 GA red welding Cable	20 ea. – 1/2" blk. heat-shrink tube
25' roll – 4 GA black welding Cable	20 ea. – 1/2" red heat-shrink tube
25' roll – 4 GA red welding Cable	5 ea. – 4 GA red terminal protector
5 ea. – 6 GA pos. top post clamp	5 ea. – 4 GA blk. terminal protector
5 ea. – 4 GA pos. top post clamp	1 ea. – heat gun
5 ea. – 6 GA neg. top post clamp	1 ea. – 9" cable cutter
5 ea. – 4 GA neg. top post clamp	1 ea. – bench mount crimping tool
20 ea. – 6 GA 5/16" MAX™ lug	1 ea. – stripping tool
20 ea. – 4 GA 5/16" MAX™ lug	1 ea. – drawer assortment box
20 ea. – 6 GA 3/8" MAX™ lug	4 ea. – dividers for box
20 ea. – 4 GA 3/8" MAX™ lug	1 ea. – custom cable poster
20 ea. – 5/16" - 18 1-1/4" bolt	



Comes with bench mount



6 GA to 4 GA Golf Cart Connector Kit

- The most popular connectors used in golf cart battery assemblies, all organized in a convenient kit
- Make your own cables in-house and turn those repair jobs around faster and put the profits in your pocket
- Quality copper terminals, precision cast by QuickCable in our factories



Part No.	Description
205900	Connector assortment for golf carts
Kit Contents	
10 ea. – 6 GA pos. top post clamp	40 ea. – 5/16" - 18 1-1/4" bolt
10 ea. – 4 GA pos. top post clamp	40 ea. – 5/16" x 18 shoulder nut
10 ea. – 6 GA neg. top post clamp	30 ea. – 1/2" blk. heat-shrink tube
10 ea. – 4 GA neg. top post clamp	30 ea. – 1/2" red heat-shrink tube
20 ea. – 6 GA 5/16" MAX lug	5 ea. – 4 GA red terminal protector
20 ea. – 4 GA 5/16" MAX lug	5 ea. – 4 GA blk. terminal protector
20 ea. – 6 GA 3/8" MAX lug	1 ea. – drawer assortment box
20 ea. – 4 GA 3/8" MAX lug	1 ea. – custom cable poster

Route Service Connector Kits

- Designed for route service vehicles
- You pick drawer assortment based on your market
- 4-drawer rack



403103
Accessories Drawer



105900
MAX™ Lugs Drawer



6190
Weather Pack Drawer

Part No.	Description
403102	Heat Shrink Ring Terminal and Butt Heat-Shrink Drawer
Kit Contents	
Heat-shrink ring: <ul style="list-style-type: none"> • 100 #10 22-18 GA • 100 1/4" 22-18 GA • 100 3/8" 22-18 GA • 100 #10 16-14 GA • 100 1/4" 16-14 GA • 100 3/8" 16-14 GA 	<ul style="list-style-type: none"> • 100 #10 12-10 GA • 100 3/8" 12-10 GA Heat-shrink butt connector: <ul style="list-style-type: none"> • 100 22-18 GA • 100 16-14 GA • 100 12-10 GA
403103	Battery Accessories Drawer
Kit Contents	
<ul style="list-style-type: none"> • 1 3/8"-16 stud nut ss (10 pc./bg.) • 1 unv. top post term. (10 pc./bg.) • 1 5/16"-18 x 1-1/4" b & n (10 pc./bg.) Heat-shrink: <ul style="list-style-type: none"> • 1 3/8" blk. 1.5" (10 pc./bg.) • 1 3/8" red 1.5" (10 pc./bg.) • 1 3/4" xhd blk. 1.5" (10 pc./bg.) • 1 3/4" xhd red 1.5" (10 pc./bg.) • 1 1-1/8" xhd blk. 1.5" (10 pc./bg.) • 1 1-1/8" xhd red 1.5" (10 pc./bg.) 	S/t bolt: <ul style="list-style-type: none"> • 1 accessory (10 pc./bg.) • 1 3/8"-16 x 13/32" (10 pc./bg.) • 1 3/8"-16 x 1" (10 pc./bg.) • 2 2/0 GA neg. (5 pc./bg.) • 2 2/0 GA pos. (5 pc./bg.) • 1 4/0 GA neg. (5 pc./bg.) • 1 4/0 GA pos. (5 pc./bg.) Lead terminal: <ul style="list-style-type: none"> • 1 marine 3/8" (5 pc./bg.) • 1 marine 5/16" (5 pc./bg.) • 1 s/t unv. (10 pc./bg.)
403105	Quick® Connector Drawer
Kit Contents	
Clamp crimp: <ul style="list-style-type: none"> • 1 1 GA neg. (5 pc./bg.) • 1 1 GA pos. (5 pc./bg.) • 1 2 GA unv. (5 pc./bg.) • 1 4 GA unv. (5 pc./bg.) • 1 1/0 GA neg. (5 pc./bg.) 	<ul style="list-style-type: none"> • 1 1/0 GA pos. (5 pc./bg.) • 2 2/0 GA neg. (5 pc./bg.) • 2 2/0 GA pos. (5 pc./bg.) • 1 4/0 GA neg. (5 pc./bg.) • 1 4/0 GA pos. (5 pc./bg.)

Part No.	Description
6190	Weather Pack Terminal Kit
Kit Contents	
<ul style="list-style-type: none"> • 50 green conn. 280 seal (500/pkg.) • 1 OEM crimp tool Weather Pack: <ul style="list-style-type: none"> • 10 1-way blk. shrd. fem. (100/pkg.) • 10 1-way blk. shrd. male (100/pkg.) • 10 2-way blk. fem. (50/pkg.) • 10 2-way blk. shrd. mle. (100/pkg.) • 5 3-way blk. fem. (750/pkg.) • 5 3-way blk. shrd. mle. (100/pkg.) • 5 4-way blk. fem. (50/pkg.) • 5 4-way blk. shrd. male (100/pkg.) • 5 3-way blk. fem. (50/pkg.) 	<ul style="list-style-type: none"> • 5 3-way blk. shrd. male (50/pkg.) • 50 18-20 GA male i-pin (200/pk.) • 50 18-20 GA term. fem. w/p slv. (200/pk.) • 50 16-14 GA i-pin (220/pk.) • 50 16-14 GA fem. slv. (2200/pk.) • 50 12 GA i-pin male (200/pk.) • 50 12 GA slv. tin fem. (200/pk.) Cable seals: <ul style="list-style-type: none"> • 50 18-20 GA green indiv (500/pkg.) • 50 16-14 GA lgt. grey (500/pkg.) • 50 12 GA blue (500/pkg.)

Part No.	Description
105900	MAX™ Lug Kit
Kit Contents	
Copper lug: <ul style="list-style-type: none"> • 10 8 GA lug 1/4" stud tin • 10 8 GA 5/16" stud tin • 10 8 GA 3/8" stud tin • 10 6 GA 1/4" stud tin • 10 6 GA 5/16" stud tin • 10 6 GA 3/8" stud tin • 5 4 GA 1/4" stud tin • 5 4 GA 5/16" stud tin • 5 4 GA 3/8" stud tin • 5 4 GA 1/2" stud tin 	<ul style="list-style-type: none"> • 5 1 GA 5/16" stud tin • 5 1 GA 3/8" stud tin • 5 1 GA 1/2" stud tin • 5 1/0 GA 5/16" stud tin • 5 1/0 GA 3/8" stud tin • 5 1/0 GA 1/2" stud tin • 5 2/0 GA 5/16" stud tin • 10 2/0 GA 3/8" stud tin • 10 2/0 GA 1/2" stud tin • 5 4/0 GA 3/8" stud tin • 5 4/0 GA 1/2" stud tin

Part No.	Description
9063	Fusion™ Solder Kit
Kit Contents	
<ul style="list-style-type: none"> • 30 1set nuts & bolts for term. (1 set) • 1 bat. side post brush (200/crtn.) • 1 flux (2 oz.) Solder Clamps: <ul style="list-style-type: none"> • 5 1/0 negative (1 ea.) • 5 1/0 positive (1 ea.) • 5 2/0 negative (1 ea.) • 5 2/0 positive (1 ea.) • 5 1 & 2 GA neg. (1 ea.) • 5 1 & 2 GA pos. (1 ea.) 	Heat-shrink: <ul style="list-style-type: none"> • 20 3/4" black (1.5" pre-cut) • 20 3/4" red (1.5" pre-cut) Solder Lugs: <ul style="list-style-type: none"> • 5 1 & 2 GA 3/8" HD sldr. (1 ea.) • 5 1/0 3/8" HD sldr lug (1 ea.) • 5 2/0 3/8" HD sldr. lug (1 ea.)

Storage Racks and Drawers

- Organize your connectors and accessories
- Drawer measures 18" x 12" x 3" and fits all major storage racks
- 12 or 24 compartments (24 shown)
- Rustproof plastic liners have rounded bottoms for easy parts removal
- Made of steel with acid-resistant enamel paint



9901



9903

Description	Part No.
Steel drawer 18" x 12" x 3" with handle & latch, black QuickCable branded enamel, 12 compartments	9900
Steel drawer 18" x 12" x 3" with handle and latch, black QuickCable branded enamel, 24 compartments	9901
4 level rack for storage drawer, easy glide slides, all steel construction	9903

Carrying Case

- Organizes your components
- Portable with locking lid
- Steel construction
- No cable, connectors or tools included.
- Used in kits 9920, 9921, 9957, 9967 and 9997



Description	Part No.
Carrying case	9929

Notes:

Custom Field Repair Kits

Ideal for truck fleets, construction companies & work sites

✓ Less down time

✓ Make or repair OEM quality cable anywhere, anytime

✓ Portable and convenient

Custom Field Repair Kits Includes -

Description	Part No.
Custom Field Repair Kits	9997-097

QuickCrimper 250



4255

- Nickel plated dies
- 26" long
- UL listed

QuickCutter™ 1



4275

- Cuts cable up to 2/0 GA
- 9 inch size, fits any tool box
- Ergonomic, insulated grips

Quick Strip Cable Stripper



4215

- Strips up to 4/0
- 5" long
- Spare blade included

Carrying Case



9929

- Organizes your components
- Portable with locking lid
- Steel construction

Pick 30 Connectors for FREE!

- Add any four bags* of UL approved Quick® Connectors FREE
- Add any two bags• of UL approved MagnaLugs FREE (each bag contains 5 pieces)

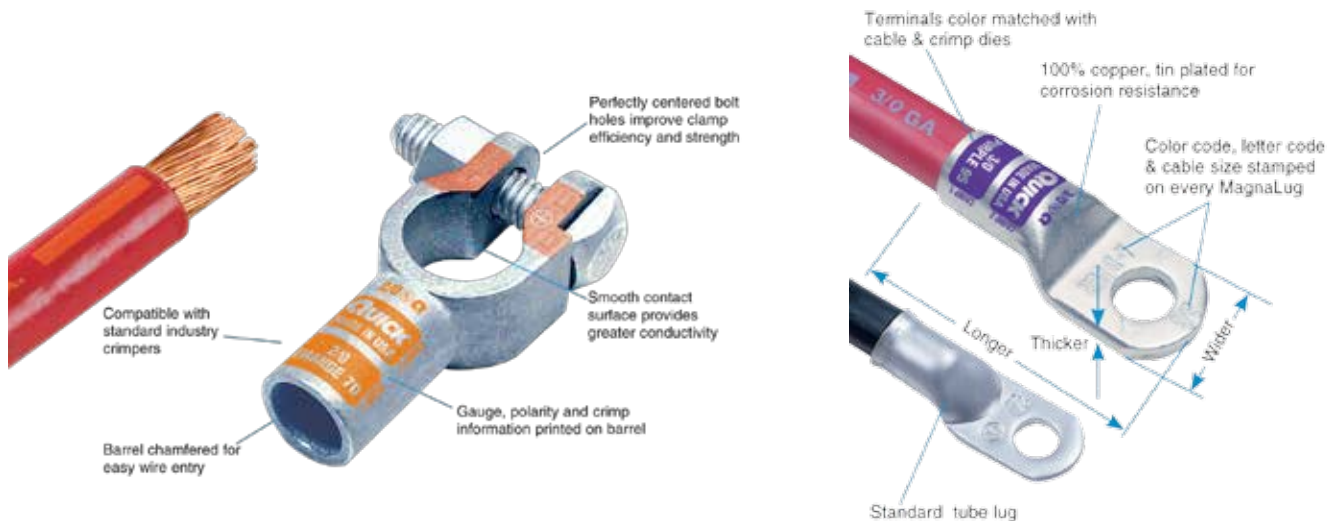

Retail Program

Our retail merchandising program presents the most popular and fastest-moving connectors and accessories in convenient, attractive packages. Smart shops put Quick components near battery accessories, lighting kits, vehicle alarms, remote starters, sound systems, and similar products so customers can get the products they need for installation all in one place. Don't send your customers down the block--sell them everything they need to complete the job with Quick merchandising.

- Hundreds of items available
- Modular system of retail ready products
- Program options include lugs, connectors, wire, cable, premade cables, jump packs, testers, chargers, tools, battery boxes, chemicals and spill kits
- Private labeling available upon request



Industry optimized planograms for -



Automotive



Battery Outlets



Agriculture & Construction



Marine/RV

Visit quickcable.com or contact your QuickCable representative for more information.

Part Number Index

2114.....	45	4202N.....	11	4360P.....	11	5030N.....	12	5531.....	15	5673B.....	56
2115.....	45	4202P.....	11	4510F.....	12	5030P.....	12	5532.....	15	5673R.....	56
2116.....	45	4204N.....	11	4520F.....	12	5030U.....	12	5533.....	15	5702B.....	57
2599.....	74	4204P.....	11	4530F.....	12	5040N.....	12	5534.....	15	5702R.....	57
3000.....	102	4206N.....	11	4801E.....	12	5040P.....	12	5535.....	15	5704B.....	57
3410U.....	12	4206P.....	11	4801F.....	12	5040U.....	12	5536.....	15	5704R.....	57
3420N.....	12	4210N.....	11	4801H.....	12	5066P.....	18	5537.....	15	5705B.....	58
3420P.....	12	4210P.....	11	4802F.....	12	5067N.....	18	5566U.....	18	5705R.....	58
3430U.....	12	4215.....	108, 156	4802F.....	12	5067P.....	18	5567N.....	18	5707B.....	58
3440P.....	12	4216.....	108	4802H.....	12	5088U.....	18	5567P.....	18	5707R.....	58
3710U.....	12	4217.....	108	4804E.....	12	5102N.....	12	5571.....	16	5709B.....	58
3720N.....	12	4218.....	108	4804F.....	12	5102P.....	12	5572.....	16	5709R.....	58
3720P.....	12	4220N.....	11	4804H.....	12	5104N.....	12	5574.....	16	5710B.....	58
3730U.....	12	4220P.....	11	4806E.....	12	5104P.....	12	5577U.....	18	5710R.....	58
3740P.....	12	4230N.....	11	4806F.....	12	5110N.....	12	5588B.....	18	5711B.....	58
4000/4000 HD...133		4230P.....	11	4806H.....	12	5110P.....	12	5588R.....	18	5711R.....	58
4000H.....	133	4240N.....	11	4808E.....	12	5120N.....	12	5588U.....	18	5712B.....	58
4001N.....	11	4240P.....	11	4808F.....	12	5120P.....	12	5611B.....	55	5712R.....	58
4001P.....	11	4245.....	106	4808H.....	12	5130N.....	12	5612R.....	55	5713B.....	58
4001U.....	11	4245K.....	106	4810E.....	12	5130P.....	12	5613B.....	55	5713R.....	58
4002N.....	11	4247.....	105	4810F.....	12	5202N.....	12	5614R.....	55	5718B.....	57
4002P.....	11	4247D.....	106	4810H.....	12	5202P.....	12	5615B.....	55	5718R.....	57
4002U.....	11	4247K.....	106	4820E.....	12	5204N.....	12	5616R.....	55	5719B.....	57
4004N.....	11	4247R.....	105	4820F.....	12	5204P.....	12	5617B.....	55	5719R.....	57
4004P.....	11	4252.....	105	4820H.....	12	5210N.....	12	5618R.....	55	5720B.....	57
4004U.....	11	4252D.....	106, 107	4830E.....	12	5210P.....	12	5619B.....	55	5720R.....	57
4006N.....	11	4252K.....	106	4830F.....	12	5220N.....	12	5619R.....	55	5721B.....	57
4006P.....	11	4252M.....	105	4830H.....	12	5220P.....	12	5651B.....	55	5721R.....	57
4006U.....	11	4252R.....	105	4840F.....	12	5230N.....	12	5651R.....	55	5722B.....	57
4008N.....	11	4254.....	105	4840H.....	12	5230P.....	12	5657B.....	56	5722R.....	57
4008P.....	11	4254D.....	106, 107	4860F.....	12	5302N.....	12	5657C.....	56	5723B.....	57
4008U.....	11	4254M.....	105	4860H.....	12	5302P.....	12	5657R.....	56	5723R.....	57
4010N.....	11	4254R.....	105	4901F.....	12	5302U.....	12	5658B.....	56	5724B.....	57
4010P.....	11	4255...13,105,106,156		4901H.....	12	5304N.....	12	5658C.....	56	5724R.....	57
4010U.....	11	4255D.....	106	4902F.....	12	5304P.....	12	5658R.....	56	5725B.....	58
4020N.....	11	4255K.....	106	4902H.....	12	5304U.....	12	5659B.....	56	5725R.....	58
4020P.....	11	4255M.....	13, 105	4904F.....	12	5310N.....	12	5659C.....	56	5726B.....	58
4020U.....	11	4255R.....	13, 105	4904H.....	12	5310P.....	12	5659R.....	56	5726R.....	58
4030N.....	11	4255U.....	106, 107	4906F.....	12	5310U.....	12	5660B.....	56	5727B.....	57
4030P.....	11	4257.....	106	4906H.....	12	5320N.....	12	5660C.....	56	5727R.....	57
4030U.....	11	4258.....	105	4910F.....	12	5320P.....	12	5660R.....	56	5728B.....	57
4040N.....	11	4258M.....	105	4910H.....	12	5320U.....	12	5661B.....	56	5728R.....	57
4040P.....	11	4258R.....	105	4920F.....	12	5330N.....	12	5661C.....	56	5729B.....	57
4040U.....	11	4260N.....	11	4920H.....	12	5330P.....	12	5661R.....	56	5729R.....	57
4050/4050 HD...133		4260P.....	11	4930F.....	12	5330U.....	12	5662B.....	56	5730B.....	57
4060N.....	11	4266.....	106	4930H.....	12	5340N.....	12	5662C.....	56	5730R.....	57
4060P.....	11	4271.....	114	4940F.....	12	5340P.....	12	5662R.....	56	5732B.....	58
4060U.....	11	4272.....	114	4940H.....	12	5340U.....	12	5663B.....	56	5732R.....	58
4101N.....	11	4273.....	115	5000.....	102	5349N.....	18	5663C.....	56	5733B.....	58
4101P.....	11	4275.....	109, 156	5002N.....	12	5350P.....	18	5663R.....	56	5733R.....	58
4102N.....	11	4277.....	114	5002P.....	12	5502U.....	17	5664B.....	56	5734B.....	57
4102P.....	11	4280.....	115	5002U.....	12	5505.....	45	5664R.....	56	5734R.....	57
4104N.....	11	4285.....	109	5004N.....	12	5506U.....	17	5665B.....	56	5735B.....	57
4104P.....	11	4285M.....	109	5004P.....	12	5507U.....	17	5665R.....	56	5735R.....	57
4106N.....	11	4287M.....	109	5004U.....	12	5510U.....	17	5666B.....	56	5736B.....	57
4106P.....	11	4301N.....	11	5006N.....	12	5513.....	19	5666R.....	56	5736R.....	57
4110N.....	11	4301P.....	11	5006P.....	12	5514.....	19	5667B.....	56	5737B.....	57
4110P.....	11	4302N.....	11	5006U.....	12	5515.....	19	5667R.....	56	5737R.....	57
4120N.....	11	4302P.....	11	5010N.....	12	5516P.....	17	5668B.....	56	5738B.....	57
4120P.....	11	4310N.....	11	5010P.....	12	5516R.....	17	5668R.....	56	5738R.....	57
4130N.....	11	4310P.....	11	5010U.....	12	5517N.....	17	5669B.....	56	5741B.....	58
4130P.....	11	4320N.....	11	5013P.....	17	5517P.....	17	5669R.....	56	5741R.....	58
4140N.....	11	4320P.....	11	5014P.....	17	5518B.....	17	5670B.....	56	5743B.....	58
4140P.....	11	4330N.....	11	5015N.....	17	5518N.....	17	5670R.....	56	5743R.....	58
4160N.....	11	4330P.....	11	5016R.....	17	5519.....	19	5671B.....	56	5745B.....	58
4160P.....	11	4340N.....	11	5020N.....	12	5520.....	19	5671R.....	56	5745R.....	58
4201N.....	11	4340P.....	11	5020P.....	12	5521.....	19	5672B.....	56	5747B.....	58
4201P.....	11	4360N.....	11	5020U.....	12	5530.....	15	5672R.....	56	5747R.....	58

5749B.....	58	6008.....	19, 20	6406D.....	13	7024.....	43	7586.....	43	7935P.....	41
5749R.....	58	6011.....	20	6406E.....	13	7027.....	43	7587.....	43	7940F.....	41
5773B.....	57	6014.....	20	6406F.....	13	7030.....	43	7588.....	43	7940H.....	41
5773R.....	57	6015.....	20	6406H.....	13	7034.....	43	7589.....	43	7940N.....	41
5774B.....	58	6016B.....	20	6408D.....	13	7037.....	43	7601.....	42	7940P.....	41
5774R.....	58	6016R.....	20	6408E.....	13	7042.....	43	7602.....	42	7945F.....	41
5775B.....	57	6019.....	20	6408F.....	13	7048.....	43	7603.....	42	7945H.....	41
5775R.....	57	6022.....	138	6408H.....	13	7052.....	43	7604.....	42	7945N.....	41
5777B.....	58	6023.....	138	6410D.....	13	7058.....	43	7625N.....	41	7945P.....	41
5777R.....	58	6024.....	19	6410E.....	13	7065.....	43	7626P.....	41	8010.....	43
5778B.....	57	6025.....	19	6410F.....	13	7072.....	43	7630N.....	41	8012.....	43
5778R.....	57	6029.....	19	6410H.....	13	7078.....	43	7631P.....	41	8015.....	43
5779B.....	57	6053.....	19	6420D.....	13	7101.....	52	7651.....	42	8020.....	43
5779R.....	57	6054.....	19	6420E.....	13	7103.....	52	7652.....	42	8024.....	43
5802F.....	12	6055.....	19	6420F.....	13	7105.....	52, 98	7653.....	42	8027.....	43
5802H.....	12	6102.....	12	6420H.....	13	7112.....	43	7654.....	42	8030.....	43
5804F.....	12	6104.....	12	6430D.....	13	7115.....	43	7655.....	42	8034.....	43
5804H.....	12	6106.....	12	6430E.....	13	7120.....	43	7656.....	42	8037.....	43
5806F.....	12	6110.....	12	6430F.....	13	7124.....	43	7701.....	42	8042.....	43
5806H.....	12	6120.....	12	6430H.....	13	7127.....	43	7702.....	42	8048.....	43
5810F.....	12	6130.....	12	6440D.....	13	7130.....	43	7703.....	42	8052.....	43
5810H.....	12	6140.....	12	6440E.....	13	7134.....	43	7704.....	42	8058.....	43
5820F.....	12	6150.....	30	6440F.....	13	7137.....	43	7751.....	42	8065.....	43
5820H.....	12	6151.....	30	6440H.....	13	7142.....	43	7752.....	42	8072.....	43
5830F.....	12	6152.....	30	6510E.....	13	7148.....	43	7753.....	42	8078.....	43
5830H.....	12	6153.....	30	6510F.....	13	7152.....	43	7754.....	42	8110.....	43
5840F.....	12	6154.....	30	6520F.....	13	7158.....	43	7755.....	42	8112.....	43
5840H.....	12	6155.....	30	6530E.....	13	7165.....	43	7756.....	42	8115.....	43
5950C.....	14	6156.....	30	6530F.....	13	7172.....	43	7780.....	43	8120.....	43
5950D.....	14	6157.....	30	6540F.....	13	7178.....	43	7781.....	43	8124.....	43
5950E.....	14	6158.....	30	6621.....	137	7320.....	44	7782.....	43	8127.....	43
5950F.....	14	6159.....	30	6622.....	137	7325.....	44	7783.....	43	8130.....	43
5950H.....	14	6160.....	30	6623.....	137	7330.....	44	7786.....	43	8134.....	43
5951C.....	14	6161.....	30	6626.....	137	7335.....	44	7787.....	43	8137.....	43
5951D.....	14	6162.....	30	6649.....	14, 15	7340.....	44	7788.....	43	8142.....	43
5951E.....	14	6163.....	30	6650.....	14, 15	7345.....	44	7789.....	43	8148.....	43
5951F.....	14	6164.....	30	6651.....	14, 15	7350.....	44	7801.....	42	8152.....	43
5951H.....	14	6165.....	30	6652.....	14, 15	7355.....	44	7802.....	42	8158.....	43
5952C.....	14	6166.....	30	6653.....	14, 15	7360.....	44	7803.....	42	8165.....	43
5952D.....	14	6167.....	30	6654.....	14, 15	7401.....	52	7804.....	42	8172.....	43
5952E.....	14	6168.....	30	6655.....	14, 15	7403.....	52	7851.....	42	8178.....	43
5952F.....	14	6169.....	30	6656.....	14, 15	7404.....	52	7852.....	42	8320.....	44
5952H.....	14	6190.....	154	6657.....	14, 15	7405.....	52	7853.....	42	8325.....	44
5953D.....	14	6201E.....	13	6698B.....	20	7410.....	44	7854.....	42	8330.....	44
5953E.....	14	6201F.....	13	6698R.....	20	7415.....	44	7855.....	42	8335.....	44
5953F.....	14	6204E.....	13	6701T.....	20	7420.....	44	7901.....	52	8340.....	44
5953H.....	14	6210F.....	13	6703.....	20	7425.....	44	7903.....	52	8345.....	44
5954D.....	14	6220F.....	13	6704.....	20	7430.....	44	7905.....	52	8350.....	44
5954E.....	14	6230F.....	13	6706.....	20	7435.....	44	7910F.....	41	8355.....	44
5954F.....	14	6240F.....	13	6708.....	20	7440.....	44	7910H.....	41	8360.....	44
5954H.....	14	6309F.....	13	6712.....	20	7450.....	44	7910N.....	41	8365.....	44
5955D.....	14	6310F.....	13	6733.....	20	7460.....	44	7910P.....	41	8410.....	44
5955E.....	14	6311F.....	13	6734.....	20	7501.....	42	7915F.....	41	8415.....	44
5955F.....	14	6312F.....	13	6753.....	20	7502.....	42	7915H.....	41	8420.....	44
5955H.....	14	6313F.....	13	6756.....	20	7503.....	42	7915N.....	41	8425.....	44
5956D.....	14	6314F.....	13	6758.....	20	7504.....	42	7915P.....	41	8430.....	44
5956E.....	14	6318F.....	13	6801.....	13	7505.....	42	7920F.....	41	8435.....	44
5956F.....	14	6319F.....	13	6804.....	13	7506.....	42	7920H.....	41	8440.....	44
5956H.....	14	6320F.....	13	6810.....	13	7510.....	44	7920N.....	41	8445.....	44
5957D.....	14	6321F.....	13	6820.....	13	7515.....	44	7920P.....	41	8450.....	44
5957E.....	14	6322F.....	13	6830.....	13	7520.....	44	7925F.....	41	8455.....	44
5957F.....	14	6323F.....	13	6840.....	13	7525.....	44	7925H.....	41	8510.....	44
5957H.....	14	6324F.....	13	6994.....	74	7530.....	44	7925N.....	41	8515.....	44
5958D.....	14	6401D.....	13	6995.....	74	7535.....	44	7925P.....	41	8520.....	44
5958E.....	14	6401E.....	13	7001.....	52	7540.....	44	7930F.....	41	8525.....	44
5958F.....	14	6401F.....	13	7003.....	52	7545.....	44	7930H.....	41	8530.....	44
5958H.....	14	6401H.....	13	7005.....	52	7550.....	44	7930N.....	41	8535.....	44
6000.....	20	6404D.....	13	7010.....	43	7580.....	43	7930P.....	41	8540.....	44
6002.....	20	6404E.....	13	7012.....	43	7581.....	43	7935F.....	41	8545.....	44
6006.....	20	6404F.....	13	7015.....	43	7582.....	43	7935H.....	41	8550.....	44
6007.....	19	6404H.....	13	7020.....	43	7583.....	43	7935N.....	41	8555.....	44

8667	2	9901	155	105077	15	107243	15	122204	67	124210	68
8801D	14	9902	151	105078	15	107244	15	122208	67	124221	68
8801E	14	9903	155	105079	15	107246	15	122209	67	124222	68
8801F	14	9906	151	105096	15	107247	15	122270	68	124223	68
8801H	14	9908	151	105097	15	107248	15	122271	68	124270	69
8804D	14	9910	151	105098	15	107249	15	122272	68	124272	69
8804E	14	9920	150, 155	105099	15	108406	19	122273	68	124273	69
8804F	14	9921	150, 155	105116	15	120101	111	122301	67	124304	68
8804H	14	9929	155	105117	15	120110	112	122304	67	124305	68
8810D	14	9930	152	105118	15	120117	112	122308	67	124307	68
8810E	14	9931	152	105119	15	120118	112	122309	67	124308	68
8810F	14	9932	152	105136	15	120119	112	122370	68	124309	68
8810H	14	9940	80	105137	15	120120	112	122371	68	124310	68
8820D	14	9942	80	105138	15	120121	112	122372	68	124321	68
8820E	14	9943	103	105139	15	120122	112	122373	68	124322	68
8820F	14	9944	103	105156	15	120123	63	122470	68	124323	68
8820H	14	9945	103	105157	15	120124	63	122471	68	124370	69
8830D	14	9946	103	105158	15	120125	63	122472	68	124372	69
8830E	14	9947	150	105159	15	120126	63	122473	68	124373	69
8830F	14	9957	151, 155	105176	15	120131	138	122504	69	124470	69
8830H	14	9967	151, 155	105177	15	120141	138	122508	69	124472	69
8840D	14	9993	150	105178	15	120145	139	122604	69	124473	69
8840E	14	9994	149	105179	15	120147	111	122608	69	124507	69
8840F	14	9995	149, 150	105900	154	120149	111	122704	69	124508	69
8840H	14	9997	155	106101	76	120151	111	122708	69	124509	69
8901D	14	9998	149	106102	76	120152	111	122804	69	124510	69
8901E	14	9999	149	106103	76	120153	113	122808	69	124607	69
8901F	14	43589	72	106104	76	120154	113	123001	69	124608	69
8901H	14	52425	18	106115	20	120155	113	123002	69	124609	69
8904D	14	100653	12	106116	20	120156	99	123101	67	124610	69
8904E	14	100655	12	106125	20	120158	113	123103	67	124707	69
8904F	14	102455	13	106126	20	120159	99	123104	67	124708	69
8904H	14	102456	13	106200	20	120160	113	123105	67	124709	69
8910D	14	102457	13	107101	15	120161	111	123107	67	124710	69
8910E	14	102458	13	107102	15	120162	111	123108	67	124807	69
8910F	14	102459	13	107103	15	120166	95, 97	123109	67	124808	69
8910H	14	102460	13	107111	15	120167	95, 97	123110	67	124809	69
8920D	14	102560	13	107112	15	120168	95, 97	123115	68	124810	69
8920E	14	102570	13	107113	15	120170	93	123130	68	125105	68
8920F	14	102580	13	107114	15	120171	93	123131	67, 68	125107	68
8920H	14	102660	13	107116	15	120172	93	123132	68	125108	68
8930D	14	102670	13	107117	15	120173	93	123142	67, 68	125109	68
8930E	14	102680	13	107131	15	120174	94	123143	67, 68	125110	68
8930F	14	102707	14	107132	15	120175	94	123144	67, 68	125205	68
8930H	14	102708	14	107133	15	120176	94	123153	68	125207	68
8940D	14	102709	14	107134	15	120177	94	123154	68	125208	68
8940E	14	102710	14	107136	15	120178	95	123156	68	125209	68
8940F	14	102717	14	107137	15	120187	96	123205	69	125210	68
8940H	14	102718	14	107161	15	120189	96	123207	69	126101	70
9001	1	102719	14	107162	15	120191	113	123208	69	126102	70
9063	154	102720	14	107163	15	120192	113	123209	69	126103	70
9103	152	102802	103	107164	15	120194	113	123210	69	126107	70
9105	152	102804	103	107166	15	120195	112	123401	67	126201	70
9106	152	102806	103	107167	15	120200	112	124101	68	126202	70
9112	41	102808	103	107168	15	120201	112	124103	68	126203	70
9113	41	102820	103	107169	15	120215	95	124104	68	126204	70
9114	41	105015	15	107186	15	120220	96	124105	68	126205	70
9122	41	105016	15	107187	15	120221	96	124107	68	126206	70
9123	41	105017	15	107188	15	120225	96	124108	68	126207	71
9124	41	105018	15	107201	15	120328	97	124109	68	126211	70
9125	152	105019	15	107202	15	120334	95, 99	124110	68	126212	70
9220N	44	105035	15	107203	15	121105	67	124121	68	126213	70
9220P	44	105036	15	107204	15	121107	67	124122	68	126214	70
9222U	44	105037	15	107206	15	121108	67	124123	68	126301	70
9510	44	105038	15	107207	15	121109	67	124201	68	126302	70
9511U	44	105039	15	107208	15	121110	67	124203	68	126303	70
9603	44	105056	15	107209	15	122101	67	124204	68	126305	70
9606	44	105057	15	107228	15	122104	67	124205	68	126401	72
9609N	44	105058	15	107229	15	122108	67	124207	68	126402	72
9609P	44	105059	15	107241	15	122109	67	124208	68	126403	72
9900	155	105076	15	107242	15	122201	67	124209	68	126411	72

126412.....72	160106.....23	160279.....24	163069.....22	164225.....21	166403.....28
126413.....72	160107.....23	160280.....24	163073.....22	164226.....21	166404.....28
126416.....72	160112.....23	160281.....24	163102.....22	164248.....21	166405.....28
126417.....72	160124.....23	160283.....25	163103.....22	164253.....21	166406.....28
126421.....72	160126.....23	160285.....25	163104.....22	164258.....21	166407.....28
126422.....72	160130.....23	160286.....25	163105.....22	164260.....21	166425.....29
126423.....72	160131.....23	160287.....25	163106.....22	164266.....21	166426.....29
126900.....70	160132.....23	160288.....25	163125.....22	164268.....21	166448.....28
126901.....70	160134.....23	160289.....25	163145.....22	164270.....21	166453.....28
127203.....70	160135.....23	160303.....23	163146.....22	164272.....21	166480.....29
127204.....70	160136.....23	160304.....23	163148.....22	164280.....21	167180.....29
127205.....73	160138.....24	160305.....23	163153.....22	164403.....21	167280.....29
127504.....73	160139.....24	160402.....23	163157.....22	164404.....21	167480.....29
127505.....73	160140.....24	160403.....23	163158.....22	164405.....21	169116.....89
127506.....73	160145.....24	160404.....23	163160.....22	164406.....21	169117.....89
127507.....72	160146.....24	160405.....23	163166.....22	164407.....21	169118.....89
127508.....72	160147.....24	160406.....23	163170.....22	164408.....21	169119.....89
127509.....72	160148.....24	160407.....23	163180.....22	164425.....21	169120.....89
127510.....72	160150.....24	160408.....23	163202.....22	164426.....21	169135.....30
127514.....73	160151.....24	160412.....23	163203.....22	164427.....21	169136.....30
127515.....73	160153.....24	160424.....23	163204.....22	164448.....21	169137.....30
127516.....73	160163.....25	160425.....23	163205.....22	164453.....21	169138.....30
127517.....72	160166.....24	160426.....23	163206.....22	164458.....21	169139.....30
127518.....72	160167.....24	160431.....23	163207.....22	164460.....21	169146.....84
127519.....72	160170.....24	160432.....23	163225.....22	164468.....21	169147.....84
127520.....72	160171.....24	160435.....23	163226.....22	164472.....21	169150.....86
127600.....71	160175.....25	160436.....23	163246.....22	164480.....21	200101.....34
127601.....71	160178.....24	160439.....24	163248.....22	164580.....21	200102.....34
127602.....71	160179.....24	160440.....24	163253.....22	164900.....26	200103.....34
127603.....71	160180.....24	160446.....24	163257.....22	164901.....26	200104.....34
141106.....11	160181.....24	160448.....24	163258.....22	164902.....26	200105.....34
141107.....11	160183.....25	160449.....24	163260.....22	164905.....26	200106.....34
141108.....11	160185.....25	160453.....24	163266.....22	165181.....27	200107.....34
141109.....11	160188.....25	160463.....25	163270.....22	165281.....27	200108.....34
141110.....11	160201.....23	160468.....24	163280.....22	165481.....27	200109.....34
141126.....11	160202.....23	160472.....24	163403.....22	165500.....26	200201.....34
141127.....11	160203.....23	160475.....25	163404.....22	165501.....26	200202.....34
141128.....11	160204.....23	160478.....24	163405.....22	165502.....26	200203.....34
141129.....11	160205.....23	160479.....24	163406.....22	165503.....26	200204.....34
141130.....11	160206.....23	160480.....24	163407.....22	165505.....26, 27	200205.....34
141136.....11	160207.....23	160481.....24	163408.....22	165600.....27	200206.....34
141137.....11	160208.....23	160483.....25	163425.....22	165601.....27	200207.....34
141138.....11	160212.....23	160485.....25	163426.....22	165602.....27	200208.....34
141139.....11	160224.....23	160488.....25	163448.....22	165606.....27	200209.....34
141140.....11	160225.....23	160504.....23	163453.....22	165607.....27	200501.....34
141207.....11	160226.....23	160505.....23	163458.....22	165608.....27	200502.....34
141208.....11	160230.....23	160506.....23	163460.....22	165800.....26, 27, 110	200503.....34
141209.....11	160231.....23	160507.....23	163480.....22	165905.....27	200504.....34
141210.....11	160232.....23	160580.....24	164102.....21	166102.....28	200505.....34
141217.....11	160234.....23	160604.....23	164103.....21	166103.....28	200506.....34
141218.....11	160235.....23	160605.....23	164104.....21	166104.....28	200507.....34
141219.....11	160236.....23	160606.....23	164105.....21	166105.....28	200508.....34
141220.....11	160238.....24	160607.....23	164106.....21	166106.....28	200509.....34
141307.....11	160239.....24	160680.....24	164107.....21	166125.....29	200601.....34
141308.....11	160240.....24	160900.....28	164124.....21	166126.....29	200602.....34
141309.....11	160245.....24	160901.....28	164125.....21	166148.....28	200603.....34
141310.....11	160246.....24	160902.....28	164126.....21	166153.....28	200604.....34
141316.....11	160247.....24	160903.....28	164148.....21	166165.....29	200605.....34
141317.....11	160248.....24	160904.....28	164153.....21	166180.....29	200606.....34
141318.....11	160249.....24	160905.....28	164158.....21	166202.....28	200607.....34
141319.....11	160251.....24	162158.....25	164160.....21	166203.....28	200608.....34
141320.....11	160253.....24	162160.....25	164166.....21	166204.....28	200609.....34
141410.....11	160263.....25	162165.....25	164170.....21	166205.....28	201702.....34
141420.....11	160266.....24	162180.....25	164180.....21	166206.....28	201703.....34
141430.....11	160267.....24	162258.....25	164202.....21	166207.....28	201704.....34
141440.....11	160268.....24	162260.....25	164203.....21	166225.....29	201705.....34
160101.....23	160270.....24	162265.....25	164204.....21	166226.....29	201706.....34
160102.....23	160271.....24	162280.....25	164205.....21	166248.....28	201707.....34
160103.....23	160272.....24	162458.....25	164206.....21	166253.....28	201802.....34
160104.....23	160275.....25	162460.....25	164207.....21	166265.....29	201803.....34
160105.....23	160278.....24	162480.....25	164224.....21	166280.....29	201804.....34

201805.....34	205405.....40	213124.....80	214350.....78	214798.....78	215826.....74
201806.....34	205406.....40	213125.....80	214351.....78	214799.....78	215830B.....75
201807.....34	205411.....40	213130.....80	214376.....77	214800.....78	215831R.....75
202102.....35	205412.....40	213131.....80	214377.....77	214825.....77	215832B.....75
202103.....35	205413.....40	213134.....80	214378.....78	214826.....77	215833R.....75
202104.....35	205414.....40	213135.....80	214379.....78	214827.....78	215840B.....75
202105.....35	205415.....40	213140.....80	214380.....78	214828.....78	215846B.....75
202106.....35	205416.....40	213141.....80	214381.....78	214829.....78	215847R.....75
202107.....35	205501.....98	213144.....80	214451.....77	214830.....78	215850B.....75
202108.....35	205502.....98	213145.....80	214452.....77	214901.....76	215851R.....75
202109.....35	205511.....98	213152.....79	214453.....78	214902.....76	215900.....89
202110.....35	205512.....98	213153.....79	214454.....78	214903.....76	215901.....89
202202.....35	205700.....46	213154.....79	214455.....78	214904.....76	215902.....89
202203.....35	205702.....46	213155.....79	214456.....78	214905.....76	215903.....89
202204.....35	205704.....46	213156.....79	214481.....77	214906.....76	215904.....90
202205.....35	205708.....46	213157.....79	214482.....77	214907.....76	215907.....89
202206.....35	205712.....46	213450.....79	214483.....78	214908.....76	215908.....89
202207.....35	205719.....46	213451.....79	214484.....78	214909.....76	215909.....89
202208.....35	205724.....46	213452.....79	214485.....78	214910.....76	215920.....90
202209.....35	205750.....46	213453.....79	214486.....78	214911.....76	217101.....146
203102.....35	205752.....46	213454.....79	214496.....77	214912.....76	217102.....146
203103.....35	205754.....46	213455.....79	214497.....77	214921.....76	217110.....146
203104.....35	205758.....46	213456.....79	214498.....78	214922.....76	217120.....146
203105.....35	205762.....46	213457.....79	214499.....78	214923.....76	217121.....146
203106.....35	205769.....46	213550.....79	214500.....78	214924.....76	217130.....144
203107.....35	205774.....46	213551.....79	214501.....78	214931.....76	217135.....144
203108.....35	205830.....46	213552.....79	214526.....77	214932.....76	217180.....146
203109.....35	205831.....46	213553.....79	214527.....77	214933.....76	217181.....146
203301.....36	205832.....46	213554.....79	214528.....78	214934.....76	217191.....146
203302.....36	205833.....46	213555.....79	214529.....78	214941.....77	217192.....146
203303.....36	205834.....46	213556.....79	214530.....78	214942.....77	217210.....144, 146
203304.....36	205835.....46	213557.....79	214531.....78	214943.....77	217230.....146
203305.....36	205836.....46	213900.....80	214601.....77	214944.....77	220101.....51
203306.....36	205837.....46	213905.....80	214602.....77	214945.....77	220102.....51
203307.....36	205838.....46	213910.....45	214603.....78	214946.....77	220104.....49
203308.....36	205839.....46	214102.....78	214604.....78	214947.....77	220106.....49
203309.....36	205840.....46	214103.....77	214605.....78	214948.....77	220109.....50
203311.....36	205900.....153	214105.....77	214606.....78	214949.....77	230000.....47
203312.....36	205910.....153	214106.....77	214631.....77	214950.....77	230001.....47
203313.....36	207001.....53	214108.....77	214632.....77	214951.....77	230002.....47
204102.....40	207102.....53	214124.....78	214633.....78	214952.....77	230003.....47
204103.....40	207103.....53	214135.....78	214634.....78	214960.....74	230004.....47
204104.....40	207105.....53	214136.....77	214635.....78	214961.....74	230005.....47
204105.....40	207110.....53	214137.....77	214636.....78	215020.....73	230006.....47
204106.....40	207114.....53	214157.....78	214646.....77	215021.....73	230009.....47
205102.....35	207120.....53	214201.....77	214647.....77	215023.....73	230100.....47
205103.....35	207130.....53	214202.....77	214648.....78	215025.....73	230101.....47
205104.....35	207140.....53	214223.....77	214649.....78	215040.....73	230102.....47
205106.....35	207206.....53	214224.....77	214650.....78	215045.....73	230103.....47
205107.....35	208107.....36	214229.....77	214651.....78	215048.....73	230104.....47
205108.....35	208108.....36	214230.....77	214676.....77	215120.....73	230105.....47
205109.....35	213020.....80	214234.....77	214677.....77	215121.....73	230106.....47
205202.....35	213021.....80	214235.....77	214678.....78	215800B.....75	230109.....47
205203.....35	213024.....80	214256.....77	214679.....78	215801R.....75	230200.....47
205204.....35	213025.....80	214257.....77	214680.....78	215802B.....75	230201.....47
205206.....35	213030.....80	214301.....77	214681.....78	215803R.....75	230202.....47
205207.....35	213031.....80	214302.....77	214750.....77	215804B.....75	230203.....47
205208.....35	213034.....80	214303.....78	214751.....77	215805R.....75	230204.....47
205209.....35	213035.....80	214304.....78	214752.....78	215806B.....75	230205.....47
205301.....40	213040.....80	214305.....78	214753.....78	215807R.....75	230206.....47
205302.....40	213041.....80	214306.....78	214754.....78	215815B.....75	230209.....47
205303.....40	213044.....80	214331.....77	214755.....78	215816R.....75	230300.....47
205304.....40	213045.....80	214332.....77	214780.....77	215817B.....75	230301.....47
205311.....40	213052.....79	214333.....78	214781.....77	215818R.....75	230302.....47
205312.....40	213053.....79	214334.....78	214782.....78	215819B.....73	230303.....47
205313.....40	213054.....79	214335.....78	214783.....78	215820B.....73	230304.....47
205314.....40	213055.....79	214336.....78	214784.....78	215821B.....73	230305.....47
205401.....40	213056.....79	214346.....77	214785.....78	215822B.....73	230306.....47
205402.....40	213057.....79	214347.....77	214795.....77	215823B.....73	230309.....47
205403.....40	213120.....80	214348.....78	214796.....77	215824B.....73	230400.....47
205404.....40	213121.....80	214349.....78	214797.....78	215825.....74	230401.....47

230402.....47	232001.....49	251302.....48	303100.....116	420222.....108	502113.....61
230403.....47	232002.....49	251303.....48	303101.....126	420223.....108	502121.....61
230404.....47	232101.....49	251304.....48	303103.....126	420224.....108	502122.....61
230405.....47	232102.....49	251305.....48	303104.....126	420230.....108	502123.....61
230406.....47	232200.....49	251306.....48	303110.....116	420241.....108	502124.....61
230409.....47	232201.....49	251309.....48	303115.....116	420500.....107	502131.....62
230500.....47	232202.....49	251400.....48	303125.....125	420501.....107	502132.....62
230501.....47	233101.....48	251401.....48	303130.....125	420506.....107	502133.....62
230502.....47	233102.....48	251402.....48	303135.....125	420507.....107	502134.....62
230503.....47	233103.....48	251403.....48	303136.....125	420550.....107	502141.....61
230504.....47	233104.....48	251404.....48	303201.....102	420580.....145	502142.....61
230505.....47	233105.....48	251405.....48	303203.....102	420581.....145	502143.....61
230506.....47	233201.....48	251406.....48	303204.....102	420582.....145	502144.....61
230509.....47	233202.....48	251409.....48	303205.....102	420583.....145	502145.....61
230600.....47	233203.....48	251500.....48	303206.....102	420584.....145	502155.....61
230601.....47	233204.....48	251501.....48	303207.....102	420585.....145	502160.....62
230602.....47	233301.....48	251502.....48	303208.....102	420590.....145	502201.....61
230603.....47	233302.....48	251503.....48	303220.....102	420591.....145	502202.....61
230604.....47	233303.....48	251504.....48	303300.....101	426301N.....10	502203.....61
230605.....47	233304.....48	251505.....48	303301.....101	426301P.....10	502204.....61
230606.....47	234101.....50	251506.....48	303302.....101	426310N.....10	502205.....62
230609.....47	234102.....50	251509.....48	303303.....101	426310P.....10	502206.....62
230700.....47	234201.....50	251600.....48	303304.....101	426320N.....10	502207.....62
230702.....47	234202.....50	251601.....48	303305.....101	426320P.....10	502208.....62
230705.....47	234301.....50	251602.....48	303306.....101	426330N.....10	502209.....62
230709.....47	234302.....50	251603.....48	308101.....98	426330P.....10	502210.....61
231200.....47	234303.....50	251604.....48	308103.....98	426340N.....10	502211.....61
231201.....47	234304.....50	251605.....48	308104.....98	426340P.....10	502212.....61
231202.....47	234401.....50	251606.....48	309101.....88	436301N.....10	502221.....61
231203.....47	235101.....51	251609.....48	309102.....88	436301P.....10	502222.....61
231204.....47	235104.....51	253101.....48	400801.....152	436310N.....10	502223.....61
231205.....47	235105.....51	253102.....48	400802.....152	436310P.....10	502224.....61
231206.....47	235110.....51	253103.....48	403102.....154	436320N.....10	502231.....62
231209.....47	235301.....51	253104.....48	403103.....154	436320P.....10	502232.....62
231210.....47	235310.....51	253201.....48	403105.....154	436330N.....10	502233.....62
231300.....47	235401.....51	253202.....48	406301N.....10	436330P.....10	502234.....62
231301.....47	235901.....51	253203.....48	406301P.....10	436340N.....10	502241.....61
231302.....47	236200.....47	253204.....48	406304N.....10	436340P.....10	502242.....61
231303.....47	236201.....47	270101.....51	406304P.....10	486301F.....10	502243.....61
231304.....47	236202.....47	270102.....51	406310N.....10	486301H.....10	502244.....61
231305.....47	236203.....47	270103.....51	406310P.....10	486304F.....10	502245.....61
231306.....47	236204.....47	270104.....51	406320N.....10	486304H.....10	502246.....61
231309.....47	236205.....47	270105.....51	406320P.....10	486310F.....10	502250.....61
231310.....47	236206.....47	270107.....51	406330N.....10	486310H.....10	502255.....61
231400.....47	236209.....47	301300.....68	406330P.....10	486320F.....10	502260.....62
231401.....47	236300.....47	301302.....68	406340N.....10	486320H.....10	502261.....62
231402.....47	236301.....47	302101.....99	406340P.....10	486330F.....10	502280.....62
231403.....47	236302.....47	302102.....99	416301N.....10	486330H.....10	502281.....62
231404.....47	236303.....47	302103.....99	416301P.....10	486340F.....10	502282.....62
231405.....47	236304.....47	302104.....100	416310N.....10	486340H.....10	502283.....62
231406.....47	236305.....47	302105.....100	416310P.....10	501010.....59	502301.....62
231409.....47	236306.....47	302106.....100	416320N.....10	501011.....59	502305.....62
231410.....47	236309.....47	302107.....100	416320P.....10	501020.....59	502309.....62
231500.....47	236400.....47	302108.....98	416330N.....10	501021.....59	502310.....62
231501.....47	236401.....47	302109.....98, 100	416330P.....10	501030.....59	502311.....62
231502.....47	236402.....47	302112.....100	416340N.....10	501031.....59	502313.....62
231503.....47	236403.....47	302115.....100	416340P.....10	501040.....59	502401.....62
231504.....47	236404.....47	302116.....100	420178.....99	501041.....59	502405.....62
231505.....47	236405.....47	302117.....100	420179.....99	501060.....59	502409.....62
231506.....47	236406.....47	302118.....100	420183.....109	501061.....59	502410.....62
231509.....47	236409.....47	302120.....98	420184.....111	501101.....59	502411.....62
231510.....47	236500.....47	302121.....98	420186.....109	501102.....59	502413.....62
231600.....47	236501.....47	302122.....98	420187.....110	501103.....59	502601.....62
231601.....47	236502.....47	302123.....98	420188.....110	501104.....59	502602.....62
231602.....47	236503.....47	302124.....100	420189.....110	502101.....61	502621.....62
231603.....47	236504.....47	302125.....100	420190.....110	502102.....61	502622.....62
231604.....47	236505.....47	302126.....100	420191.....30	502103.....61	502900.....110
231605.....47	236506.....47	302201.....98, 100	420192.....110	502104.....61	502901.....110
231606.....47	236509.....47	302202.....100	420193.....109	502110.....61	502902.....110
231609.....47	251300.....48	302203.....99	420201.....108	502111.....61	502903.....110
231610.....47	251301.....48	302204.....99	420221.....108	502112.....61	502904.....110

503151.....60	505210.....60	509205.....83	509686.....88	602170.....37	608002.....115
503152.....60	505301.....60	509206.....83	509687.....88	602200.....37	670144.....87
503153.....60	505302.....60	509207.....83	509688.....59	602203.....37	670177.....87
503154.....60	505303.....60	509208.....83	509690.....88	602205.....37	670178.....87
503155.....60	505304.....60	509209.....83	509691.....88	602220.....37	730224.....45
503156.....60	505306.....60	509215.....85	509692.....88	602222.....37	730234.....45
503251.....60	505900.....110	509221.....83	509693.....88	602224.....37	730237.....45
503252.....60	506390.....56	509222.....83	509695.....88	602226.....37	730242.....45
503253.....60	506391.....56	509223.....83	509696.....88	602260.....37	730248.....45
503254.....60	506590.....56, 85	509224.....83	509697.....88	602270.....37	730252.....45
503255.....60	506591.....56, 85	509225.....83	509698.....88	602271.....37	730265.....45
503256.....60	506701.....55	509226.....83	509699.....87	602280.....37	730272.....45
504401.....63	506702.....55	509230.....83	509701.....84	602281.....37	850105.....16
504402.....63	506703.....55	509231.....83	509702.....84	602282.....37	850109N.....16
504403.....63	506704.....55	509232.....83	509710.....87	602310.....37	850109P.....16
504404.....63	506711.....55	509233.....83	509711.....87	602320.....37	850112.....18
504405.....63	506712.....55	509240.....83	509713.....88	602330.....37	850113.....18
504406.....63	506713.....55	509245.....83	509714.....88	602332.....37	850115.....19
504407.....63	506714.....55	509298.....84	509716.....87	602340.....37	850116.....19
504408.....63	506790.....56, 85	509299.....84	509717.....87	602345.....37	850118.....18
504409.....63	507101.....64	509300.....84	510130.....142	602350.....37	850119.....18
504421.....63	507110.....64	509301.....84	510135.....142	602360.....37	850120D.....16
504422.....63	507201.....52	509302.....84	510140.....140	602370.....37	850120E.....16
504423.....63	507211.....52	509303.....84	510142.....141	602380.....37	850120F.....16
504424.....63	509101.....83	509304.....84	510145.....140	602390.....37	850120H.....16
504425.....63	509102.....83	509305.....84	510146.....138	602400.....37	850130D.....16
504427.....63	509103.....83	509306.....84	510147.....141	602410.....37	850130E.....16
504429.....63	509104.....83	509307.....84	510148.....140	602420.....37	850130F.....16
504431.....63	509105.....83	509308.....84	510156.....140	602500.....39	850130H.....16
504501.....63	509106.....83	509401.....84	510160.....140	602510.....39	850140D.....16
504502.....63	509107.....83	509402.....84	510170.....142	602520.....39	850140E.....16
504503.....63	509108.....83	509403.....84	510171.....142	602550.....39	850140F.....16
504504.....63	509109.....83	509404.....84	510251.....145	602560.....39, 135	850140H.....16
504505.....63	509110.....83	509411.....84	510332.....90	602562.....135	850150.....18
504506.....63	509115.....85	509412.....84	510335.....137	602563.....135	850151.....18
504507.....63	509121.....83	509413.....84	510346.....140	602564.....135	850160.....18
504508.....63	509122.....83	509414.....84	510400.....138	602570.....39, 135	850161.....18
504509.....63	509123.....83	509418.....84	510410.....138	602580.....39	850211N.....16
504511.....63	509124.....83	509421.....83	510420.....139	602585.....39	850211P.....16
504611.....63	509125.....83	509422.....83	510430.....139	602590.....39	850220D.....16
504612.....63	509126.....83	509423.....83	510450.....139	602600.....39	850220E.....16
504613.....63	509127.....83	509424.....83	510900.....141	602610.....39	850220F.....16
504614.....63	509128.....83	509503.....84	510901.....141	602620.....39	850220H.....16
504615.....63	509129.....83	509601.....86	510902.....141	602630.....39	850230D.....16
504621.....63	509130.....83	509602.....86	510950.....137	602640.....39	850230E.....16
504622.....63	509131.....83	509605.....86	602005.....38	602700.....39	850230F.....16
504623.....63	509132.....83	509606.....86	602007.....38	602705.....39	850230H.....16
504624.....63	509133.....83	509611.....86	602010.....38	604022.....130	850240D.....16
504625.....63	509140.....85	509612.....86	602020.....38	604039.....129	850240E.....16
504631.....63	509150.....83	509621.....86	602021.....38	604049.....129	850240F.....16
504632.....63	509151.....83	509631.....86	602030.....38	604050.....131	850240H.....16
504633.....63	509152.....83	509640.....86	602035.....38	604051.....131	850250.....19
504641.....63	509153.....83	509641.....86	602036.....38	604053.....132	850350.....19
504642.....63	509154.....83	509642.....86	602040.....38	604055.....2, 132	990170.....101
504643.....63	509155.....83	509643.....86	602045.....38	604061.....135	990171.....101
505101.....60	509156.....83	509650.....86	602050.....38	604063.....132	990172.....101
505102.....60	509157.....83	509660.....86	602055.....38	604082.....132	990173.....101
505103.....60	509160.....85	509661.....84	602058B.....38	604083.....131	990174.....101
505104.....60	509170.....83	509665.....85	602058K.....38	604084.....131	990175.....101
505105.....60	509183.....83	509666.....85	602058R.....38	604089.....135	990176.....101
505106.....60	509184.....83	509668.....87	602060.....38	604095.....135	990177.....101
505107.....60	509185.....83	509669.....87	602065.....38	604100.....133	990190.....145
505110.....60	509186.....83	509670.....87	602070.....38	604101.....133	990211.. 144, 145, 146
505201.....60	509187.....83	509671.....87	602071.....38	604105.....133	990221.....144
505202.....60	509188.....83	509675.....87	602072.....38	604106.....133	
505203.....60	509189.....83	509676.....87	602100.....37	604110.....133	
505204.....60	509200.....85	509677.....87	602110.....37	604115.....133	
505205.....60	509201.....83	509678.....87	602120.....37	604120.....134	
505206.....60	509202.....83	509680.....88	602140.....37	604300.....130	
505207.....60	509203.....83	509681.....88	602145.....37	604301.....130	
505208.....60	509204.....83	509685.....88	602160.....37	608001.....115	

Product Index

A

Absorbent Pillows & Socks 146
Access-A-Fuse 83
Accessories
A-Frame Handles 70
Auto Reset Blade 83
Battery Cap Tool 90
Battery On/Off Switch 88
Battery Vent Caps 89
Bayonet Vent Cap 89
Econ-O-Flip Vent Cap 89
High Profile Vent Cap 90
Low Profile Vent Cap 89
Watermiser Vent Cap 89
Breakers 83
Auto Reset 84
Manual Reset 84
Cable Clamps 70
Cable Tower 71
DIN Manual Release 70
Disconnect Adapters 30
Distribution
Panel Bushings 87
Power Post-8 Point 88
Power Post-Single-Point 88
Expandable Sleeving 60
Fuses 83
Access-A-Fuse 83
AGU Fuse Block 86
ANL Type Power Fuses 84
ATC/ATO Fuse Pullers 84
ATC Fuse Tap-In 84
Fuse Boxes-Standard Blade Fuses 84
Glass Fuses 83
Large Glass Power Fuses 83
Low Profile Fuses 83
Maxi Blade Fuses 83
Mini Blade Fuses 83
Water Resistant ANL Fuse Holder 84
Fuses Holders 86
AGC Glass Fuse 86
ATC ATO Blade & Cap 86
ATC ATO Open Blade 86
ATC ATO Sealed Standard Blade 86
Crimp Type Yellow AGC 86
Maxi Fuse & Cap 86
Mini Blade Fuse & Cap 86
Panel Mount Glass AGC 86
Self Stripping ATC ATO 86
Heat-Shrink Tube 55
FlexTube 56
SpliceTube 55
JumpStart
Block Surface Mount 87
Connector Conductor Posts 87
Connector Plugs 88
OEM Style Caps 59
Connection Point Insulator 59
Heavy Duty Type-T & Group 31-T 59
Lawn and Garden Post Cap 59
Lead Free Terminal Protector 59
Nylon Marine Cap 59
Side Post Rigid Battery Cap 59
Top Post Rigid Battery Cap 59
Safety Boots 72
Protective Caps 72
Quick Protective Kit 72
Quick Safety Boots 72
Safety Lockout 70
SB Extraction Tool 70
SB Handle 70
SB Lock Box 71
SB Manual Releases 70
SBX Manual Releases 70
Split Loom 60
Nylon Split Loom 60
Polyethylene Split Loom 60
Split Wrap 60
Terminal Bus Bar 87
Terminal Protectors 57, 58
Automotive Lug 57
Dual-Post Insulator 58
Elbow Terminals 57
Flag Clamps 58
Garden Tractor and L Terminal 58
Heavy Duty Starter 57
Marine Terminal-Fixed 58
Marine Terminal-Swivel 58
Medium Duty Starter 57
Military Style 58
Side Terminal Cover 58
Snap-On Insulator 57
Straight Clamps 57
Straight Clamps-Snap Fit 57
Straight or Angled Lug 57
Tab Insulator 58
T Handle 70
Water Sensor 90
Probe Style 90
Wire Connectors 89
Acid Absorbent Pillows & Socks 144
Acid Containment Pallets 145
Acid Spill Absorber & Neutralizer 142
Acid Spill Kits 143
Adapter Bolts and Nuts 19
Adapter Bushings 19
Adapter for JIS (Pencil Post) 19
Aero Connection Kit 135
Aftermarket Pre-Made Automotive Cables 43
AGC Glass Fuse Holders 86
AGU Fuse Block 86
Analog Battery Load Analyzer 126
Analog Battery Load Tester 126
Analog Battery Testers 126
Angled Battery Pliers 113
Angled Lug 57
ANL Fuse Holder 85
ANL Type Power Fuses 84
ATC ATO Blade Fuse Holder/Cap 86
ATC/ATO Fuse Pullers 84
ATC ATO Open Blade Fuse Holder 86
ATC ATO Sealed Standard Blade Fuse Holder 86
ATC Fuse Tap-In 84
Auto Battery Box 93
AutoMeter
Battery Testers 126
12-Volt Digital Battery Resistance Tester 126
Analog Battery Load Analyzer 126
Analog Battery Load Tester 126
Benchtop Battery Testers 119, 120

Carbon Pile 119
Buss Chargers 123
Handheld Battery Testers 116, 117, 118
Professional Grade 117
Technician Grade 116
Infrared External Printer 125
Microprocessor Chargers 121, 122
XCPR0-80 122
XTC-160 123
Automotive Battery Cleaner 140
Automotive Booster Cables 37
Automotive, Heavy Duty 18
Automotive Lug 57
Automotive Tie Bolt Style 44
Auto Reset Blade 83
Auto Reset Circuit Breakers 84

B

Battery Acid Containment System 146
Battery Acid Counter Mat 142
Battery Acid Floor & Counter Mat 142
Battery Acid Floor Mat 142
Battery Box 93
Base Mount Parts 99
Battery Inverters 102
Battery Isolators 101
Battery Rack 145
Battery Trays 98
Commercial Boxes 95
Cover 93
Hold-Down 99
Hold-Downs & Rods 98
Inverter Connectors 103
Mounting Brackets 99
Rods for Golf Carts 100
Tie Down 99
Battery Boxes and Racks 93
Battery Box Vent Kit 97
Battery Cable 33
Fine Stranded 33
Battery Cap Tool 90
Battery Charger 115, 121, 122
Battery Cleaners 139
Battery Connectors 18
Battery Connectors Kits 72, 73
DIN 72, 73
Battery Corrosion Preventatives 138
Battery Disposal Bags 137
Battery Drip Pan 96
Battery Harness 42
Battery Inverters 102
Battery Isolators 101
Battery Jumpers 42
Battery Leaker Kit 137
Battery Maintenance Kits 141
Battery Maintenance Tools 111
Battery On/Off Switch 88
Battery Post Shims 19
Battery Rack 144, 145, 146
Battery Rack Cable Kits 101
Battery Recycling 137
Battery Relocation Kits 98
Battery Terminal Adapters 19
Battery Terminal Protection Kit 139
Battery Terminals 12
Battery Terminal Wipes 140

- Battery Tray 96
- Battery Trays 98
- Battery Vent Caps 89
- Battery Washers 137
- Battery Wash Water Treatment 140
- Battery Wipedown 141
- Bayonet Vent Cap 89
- BCT-200J 118
- Bench Mount Crimp Tool 105
- Benchtop Battery Testers 119, 120
- Black Battery Reconditioner Paint 139
- Bolt Sets 100
- Booster Cable 37, 40
 - Plug-Ins 39
 - Twin Conductor 40
- Booster Clamps 38
 - Surge Protectors 39
- Booster Pack 129, 130, 131, 132, 133, 134
- Braided Ground Straps 52
- Brazed Seam - Non-Insulated Lugs 15
- Brute Hammer Crimper 106
- Bullet Male 24
- BusPro 360 123
- BusPro 361 124
- BusPro 600S 124
- BusPro 620S 124
- BusPro 660 125
- BusPro 662 125
- Buss Bar 123, 124
- Buss Chargers 123
- Butane Torch 115
- Butt Connector 21, 22, 24, 29
- Butt Connectors 26, 27
- BVA-34 120
- BVA-36/2 120
- BVA-230 117
- BVA-260 118
- BVA-300 116
- BVA-350 117
- BVA-2100 121

C

Cable

- Automotive Cables 43
- Battery Cable 33
 - Fine Stranded 34
 - Offset Jumpers 43
 - Quick Harnesses 42
 - Quick Replacement Ends 44
 - SGX 35
 - Standard 34
 - UL Marine 34
- Battery Jumpers 42
- Booster Cable
 - Twin Conductor 40
- Commercial & Industrial Equip.
 - QuickLinks 2/O Cables & Jumpers 41
 - QuickLinks & Input/Output 40
- Control Cable 49
 - TC Cable 49
- DLO RHH/RHW 36
- Golf Cart Cables 46
- Machine Tool Wire (MTW) 36
- Pre-Made Cables 77
- Trailer Cable 50
- Welding Cable 35
 - QuickFlex 35
 - UL QuickFlex Tinned 35
- Cable Clamps 70
- Cable Crimpers 105

- Cable Cutters 109
- Cable Kits 101
- Cable Maintaining Kits 149
- Cable Strippers 108
- Cables with Lead Wires 45
- Cable Tie Mounting Pad 62
- Cable Ties 61
 - Acid-Resistant 62
 - Cold Weather 62
 - Extra Heavy Duty 62
 - Fluorescent 62
 - I.D. 61
 - Metal Table Premium 62
 - Mounting Hole 61
 - Push Mount 61
 - Releasable 61
 - Standard Cable Ties 61
- Cable Ties Tools 110
- Cable Tower 71
- Carbon Arcing Cable Assembly 80
- Carrying Case 155
- Charger 115
 - Charger & Maintainer 115
 - Microprocessor Charger 121, 122
- Chargers
 - Buss Chargers 123
- Charging Clips 38
- Chemicals
 - Acid Spill Absorber & Neutralizer 142
 - Automotive Battery Cleaner 140
 - Battery Cleaner 139
 - Battery Corrosion Preventatives 138
 - Acid Neutralizer 138
 - Clear Silicone Sealant 138
 - Original Red Aerosol Formula 138
 - Protective and Cleaner Sprays 138
 - Battery Leaker Kit 137
 - Battery Rack 146
 - Battery Reconditioner Paint 139
 - Battery Terminal Wipes 140
 - EZ-Zorber 142
 - Industrial Battery Cleaner 140
 - Battery Wash Water Treatment 140
 - Stationary Battery Wipedown 141
 - Stationary Battery Wipes 141
 - Plastic & Glass Cleaner 139
- Circuit Breakers 84
- Circuit Tester 111
- Clamp Connector Lifter 113
- Clamps Booster 38
- Clamp Spreader/Reamer 113
- Clear Silicone Sealant 138
- Commercial Battery Box 95
- Cones 76
- Cone/Thimble 76
- Connection Point Insulator 59
- Connector Heavy-Duty Kit 151
- Connector Kits 68, 151
- Connectors
 - Battery Connectors 18
 - Automotive, Heavy Duty 18
 - Lead-Free Connectors 16
 - Battery Terminal Adapters 19
 - Adapter Bolts and Nuts 19
 - Adapter Bushings 19
 - Adapter for JIS (Pencil Post) 19
 - Battery Post Shims 19
 - SAE to JIS (Pencil Post) Conversion 19
 - Side Terminal-to-Post Conversion 19
 - Specialty Terminal with Pole-to-Top Post 19

- Stud-to-Post Conversion 19
 - Top Post-to-Side Terminal Connectors 19
- Battery Terminals 18
- Die-Cast Copper Compression Kit 152
- Fastener Hardware 20
- Fusion
 - Cast Connectors 10
 - Magna Lug 11
 - Magna Lugs 11
 - SB Solder Contacts 67
 - Heavy Duty Marine Connectors
 - 3-Way Connectors 18
 - Military Style Connectors 18
 - Quick Disconnect 18
 - Right Angle Heavy Duty Brass Terminals 18
 - Set Screw 17
 - MagnaLug Kit 152
 - MagnaLugs
 - Heavy Wall Copper Tube Lug 13, 14
 - Marine Terminals 17
 - Max Lug 9, 14, 15
 - Copper Tube Lugs 14, 15
 - Max Lug Kit 152
 - PowerPole 68
 - Quick Battery Connectors
 - Precision Die Cast 11
 - SB Connector Contacts Original 67
 - SB Connector Housings 67
 - SBX Battery Connector 69
 - Wall Copper Tube 11
 - Weatherproof 300 SB® Amp Connector 68
- Containments 146
 - Acid Containment Pallets 145
 - Battery Disposal Bags 137
 - Battery Trays & Drip Pans 96
 - Battery Washers 137
 - Corners 146
 - Liner Clip 146
 - Pallet Strapping Kits 145
 - PVC Liner 146
 - PVC Rail 146
 - Stainless Steel Rails 146
- Containment System for Battery Rack 146
- Continuous Loop 51
- Control Cable 49
- Copper Die Cast 10
- Copper Tube Lugs 14, 15
- Copper Tube Thick Wall (MagnaLug) 13
- Copper Tube Thin Wall (MAX) 14, 15
- Corners 146
- Crimp 109
 - Bench Mount Tool 105
 - Brute Hammer Crimper 106
 - Cable Crimpers 105
 - Crimp AGC Fuse Holder 86
 - Crimper Service Parts 106
 - Crimp Kit 68
 - Crimp Tool 105, 106, 107, 109
 - Cub Crimper 106
 - Heavy Duty with Cutter 109
 - Pneumatic Crimp Tool 107
 - Ratchet Crimp Tool 105
- Cup Jumper Cables 45
- Custom Field Repair Kits 156
- Cutters 109
 - Heavy Duty 109
 - QuickCutter 1 109
 - QuickCutter 250 109
 - QuickCutter 500 109

D

Deflectors 114
Die-Cast Copper Compression Connector Kits 152
DIN Handle Kit 73
DIN Manual Release 70
Disconnect Adapters 30
DLO RHH/RHW Cable 36
Drawers 155
Dual Battery Box 94
Dual-Post Insulator 58

E

ECM/ECU/PCM Memory Saver Cable OBD II 135
Econ-O-Flip Vent Cap 89
Elbow Terminals 57
Electrical Tape 64
Electrician's Automatic Wire Stripper 110
EPDM Stainless Steel Covered Clamps 63
EPDM Steel Covered Clamps 63
Expandable Sleeving 60
EZ-Zorber 142

F

Fast Charge Leadheads 79
Fastener Hardware 20
Female 160 Amp Connector Kit 73
Female Bullet 21
Female DIN Connector Kits 72
Female Disconnect 21, 22, 24, 28
Field Repair Kits 150
Filler Bulb 111
Filler Jug 111
Fine Stranded Battery Cable 34
Flag Clamps 58
Flag Female Disconnect 29
Flameless Heat Gun 115
Flange Spade 23
FlexTube 56
Floor Mat 142
Ford® Truck Positive Cable 45
Fuse
 Access-A-Fuse 83
 ANL Type Power Fuses 84
 ATC/ATO Fuse Pullers 84
 ATC Fuse Tap-In 84
 Auto Reset Blade 12V Type 1 83
 Auto Reset Circuit Breakers 6-24V Type 1 84
 Fuse Boxes Standard Blade Fuses 84
 Fuse Holder 85
 Fuses Kits 85
 Glass Fuses 83
 Large Glass Power Fuses 83
 Low Profile Fuses 83
 Maxi Blade Fuses 83
 Mini Blade Fuses 83
 Standard Blade Fuses 83
 Water Resistant ANL Fuse Holder 84
Fusion 67, 68
 Butt Connectors 27

G

Garage Kits 150
Garage Maintenance Kit 151
Garden Tractor and L Terminal 58
Gardian 21

Solderless Heat Shrink Terminals 21
Solderless Non-Insulated Extreme Environment 21
Glass Fuses 83
Golf Cable Sets 46
Golf Cart Cables 46
Golf Cart Cable Starter Kit 153
Golf Carts 100
GPT General Purpose 47
Ground Strap 52

H

Handheld Battery Testers 116, 117, 118
HD Compression Style 44
Heat Guns 114
Heat Shrink Kits 56
Heat-Shrink Tube 55
 FlexTube 56
 MagnaTube 55
 PrimaryTube 56
 SpliceTube 55
Heavy Duty Booster Cables 37
Heavy Duty Cutter/Crimper 109
Heavy Duty Ratchet Crimpers 110
Heavy Duty Ring 23
Heavy Duty Starter 57
Heavy Duty Starter Kits 149
Heavy Duty Type-T 59
Heavy Wall Copper Tube Lug 13, 14
HexCrimp Pneumatic 107
High Profile Vent Cap 90
Hold-Downs 98
Hook 24
Hydrometers 111

I

In-Cab Charging Cord 135
Industrial Battery Cleaner 140
Infrared External Printer 125
Insulated Bullet Male 22
Insulated Female Bullet 22
Insulated Female Disconnect 21, 22
Insulated Male Disconnect 21, 22
Intercell Connectors 73
Intercell Shroud: Black 73
Intercell Shroud: Blue 74
Inverter Installation Kits 103
Inverter Remote Starter 102
Inverters 102
iQ2 Battery Charger 115
iQ4 Battery Charger 115
Isolators 101
iStart 700 129
iStart Li-Lon 129

J

Jacketed Marine Wire 48
Jump Pack 129, 130, 131, 132, 133, 134
Jumpstart Connector Conductor Posts 87
Jumpstart Connector Plugs 88
Junction Block Surface Mount 87

K

Kits
 Battery Acid Spill 143
 Battery Box Vent 97
 Battery Leaker Kit 137
 Battery Maintenance 141

Battery Rack 144
 Cable Kits 101
 Seismic Kit 144
Battery Terminal Protection Kit 139
Cable
 Heavy Duty Starter Kits 149
 Medium Duty Starter Kit 150
Carrying Case 155
Connectors
 Crimp Kit 68
 Die-Cast Copper Compression 152
 EBC/DIN Battery Connectors 72, 73
 Female 160 Amp 73
 Female DIN 72
 Male 160 Amp 73
 Male DIN 72
 Fusion 68
 Heavy-Duty/Die-Cast Crimp 151
Die-Cast Copper Compression 152
Field Repair and Garage 150
 Custom Field Repair Kits 155
 Custom Golf Cart Cable Starter kit 153
 Garage Maintenance Kit 151
 Golf Cart Connector Kit 153
 Heavy Duty Field Repair Kits 150
 Medium/Light Duty Field Repair Kit 151
Fuses and Breaker 85
Golf Cart Connector Kit 153
Heat Shrink 56
 Tube Kits 56
Inverter Installation 103
MagnaLugs 152
MAX 152
PowerPole 69
SB Connector 68
 Crimp Kit (1 housing, 2 contacts) 68
 DIN Handle Kit 73
 Fusion Kit (1 housing, 2 contacts) 68
 SBX Auxiliary Kit 69
 SBX Kits 69
SB Connectors Kits 152
Storage Racks and Drawers 155
Terminal Kits 28
 Premium Nylon Solderless Kit 26
 PVC Solderless Connector Kits 28
Vehicle Starter Kits 149

L

Large Glass Power Fuses 83
Lawn and Garden Post Cap 59
Lead-Free Connectors 16
Lead Free Terminal Protector 59
Lead Free with Axillary Take-Off 16
Leadhead Drill 80
Leadheads
 Intercell Connectors 73
 8D Bus Bar Terminals 74
 Intercell Shroud: Black 73
 Intercell Shroud: Blue 74
 Lead Stick Burn Bar 74
 Small Bore "L" Terminal 74
Leadhead Cones 76
Leadhead Shrouds 75
Standard Bore 77
Universal 79
 Post Mold 80
Leadhead Shrouds 75
Lead Stick Burn Bar 74
Lead Straight Jumpers 42
LiFePO4 130

LiFePO4 200 130
LiFePO4 400 130
LiFePO4 800 130
Light Duty Field Repair Kit 151
Liner Clip 146
Liquid Flux 16
Locking Spade 23
Loom 60
Low Profile Fuses 83
Low Profile Vent Cap 89
L Terminal 74

M

Machine Tool Wire 36
MagnaLug 9, 13, 103
 Inverter Connectors 103
MagnaLugs 152
Maintainer 115
Male 160 Amp Connector Kit 73
Male Bullet 21
Male DIN Connector Kits 72
Male Disconnect 21, 22, 24, 28
Marine
 Battery Box 93
 Jacketed Marine Wire 48
 Marine Battery Cable 34
 Marine Primary Wire 48
 Terminal Protector - Fixed 58
 Terminal Protector - Swivel 58
 Terminals 17
Material Handling
 Intercell Connectors 73
 8D Bus Bar Terminal 74
 Intercell Shroud 73
 Leadhead Shrouds 75
 Lead Stick Burn Bar 74
 L Terminal 74
 Leadhead Cones 76
 Leadheads - Fast Charge 79
 Leadhead - Standard Bore 77
 Leadhead - Universal 79
 PowerPole 68
 SB Connector Contacts Original 67
 SB Crimp Contacts 67
 SB Connector Housings 67
 SB Solder Contacts 67
 SBX Battery Connector 69
 Weatherproof 300 SB Amp Connector 68
Maxi Blade Fuses 83
Maxi Fuse Holder/Cap 86
Max Lug, Copper Tub Lug 9, 14
Medium Booster Cables 37
Medium Duty Field Repair Kit 151
Medium Duty Starter 57
MEGA Fuse Holder 85
Memory Saver Cables 135
Microprocessor Chargers 121, 122
Military Style 58
Military Style Connectors 18
Mini Blade Fuse Holder/Cap 86
Mini Blade Fuses 83
Mounting Brackets 99
Multi-Battery Assemblies 42
Multi-Conductor Flat Jacketed 48
Multi-Stud Ring 23

N

Non-Insulated Solderless 28, 30
Nylon Cable Clamps 63

Nylon Marine Cap 59
Nylon Ring Double Crimp 22
Nylon Split Loom 60
Nylon Terminals 25

O

OEM 16
OEM Style Caps 59
Offset Jumpers 43
Original Red Aerosol Formula 138
Overmolded Battery Assemblies 41

P

Pallets Containment 145
Pallet Strapping Kits 145
Panel Bushings 87
Panel Mount Glass AGC Fuse Holder 86
Parallel Bonded 49
Parallel Butt Connector 24
Plastic & Glass Cleaner 139
Plugs - Male and Female 52
Pneumatic Crimp Tool 107
Pointer Style Hydrometer 111
Polyethylene Split Loom 60
Portable Cord 51
Portable Power Packs 129
Post Terminal Brush 112
Power Brush 112
Power Distribution Post 88
Power Pack 129, 130, 131, 132, 133, 134
Power Pack Accessories 135
PowerPole 68
PowerPole Kits 69
Precision Die Cast 11, 12
Premium Nylon Double Crimp Terminals 22
Premium Nylon Solderless Kit 26
Primary Wire 47
Primary Wire Tools 109
Probe Style 90
Protective and Cleaner Sprays 138
Protective Caps 72
PVC Liner 146
PVC Rails 146
PVC Solderless Connector Kits 28
PVC Terminals 23

Q

Quick 105, 107, 114
QuickCote 138
QuickCote+ w/ Acid Neutralizer 138
Quick Crimp Pneumatic 107
QuickCutter 109
Quick Disconnect 18
QuickFlex 35
QuickFlux 16
QuickHarnesses 42
QuickHeat 114
QuickHold 99
QuickLinks 40
 Cables and Jumpers 41
 Input/Output Cables 40
Quick Protective Kit (Boot & Cap) 72
Quick Replacement Ends 44
Quick Safety Boots 72
QuickStrip 108

R

Racks 144, 145, 146, 155

Rack Storage 155
Ratchet Crimp Tool 105
RC-300 116
Relocation Kits 98
Repair Kits 150
Replacement Ends 44, 45
Rescue 135, 143, 146
 900 131
 910 131
 950 131
 1060 131
 1220 Aero 132
 1800 132
 2100 132
 3000 132
 4000/4000 HD 133
 4050/4050 HD 133
 5000 133
 5020 Aero 133
 6000 134
Retail Program 157
Right Angle Heavy Duty Brass Terminals 18
Ring 16, 21, 23, 28
Ring Flag 16
Route Service Connector Kits 154
Rubber Grommets 63, 64
RV Battery Box 93

S

SAE to JIS (Pencil Post) Conversion 19
Safety Boots 72
Safety Glasses 111
Safety Lockout 70
SB 152
SB-3 119
SB-5/2 119
SB-300 116
SB Connector Contacts Original 67
SB Connector Housings 67
SB Connector Kits 68
SB Crimp Contacts 67
SB Extraction Tool 70
SB Lock Box 71
SB Manual Releases 70
SB Solder Contacts 67
SBX Auxiliary Kit 69
SBX Battery Connector 69
SBX Contacts 69
SBX Housings 69
SBX Kits 69
SBX Manual Releases 70
Scissors Carriers 113
Seamless Butt Connector 29
Securing Base Mount Parts 99
Seismic Kit 144
Self Stripping ATC ATO Fuse Holder 86
SEOW Cable 50
Set Screw 17
SGX Battery Cable 35
Side Lift Carrier 113
Side Post Rigid Battery Cap 59
Side Terminal Brush 112
Side Terminal Cables with Lead Wire 44
Side Terminal Cover 58
Side Terminal Ratchet Wrenches 112
Side Terminal-to-Post Conversion 19
Silicone Tape 64
Single Battery Box 94
SJO Cord 51
SJOOW Cord 51

Small Bore "L" Terminal 74
Snap-On Insulator 57
Solder, Flux and Paste 15
Soldering Paste Flux 16
Solderless Terminals 21
Heat Shrink (Gardian) 21
Nylon Double Crimp 22
PVC 23
Spade 21, 23, 29
Spade Double Crimp 22
Specialty Terminals and Connectors 26
Specialty Terminal with Pole-to-Top Post 19
Spill Kits 143
Spiral Wrap 60
SpliceTube 55
Split Loom 60
Split Wrap 60
Stainless Steel Rails 146
Standard Battery Cable 34
Standard Blade Fuses 83
Standard Bore 77
Standard Cutter/ Crimper Tool 109
Starter Kits 149, 150
Stationary Battery Wipes 141
Straight Clamps 57
Straight Lug 57
Strap Carriers 113
Strippers 108, 109
QuickStrip LS 108
Stud Size Guide 9
Stud-to-Post Conversion 19
Stud-to-Power Take Off Post 42
Surge Protectors 39
Switch to Starter Cables 44
SXL Cross-Linked Polyethylene 47

T

Tab Insulator 58
TC Cable 49
Terminal Bus Bar 87
Terminal Kits 28
Terminal Protectors 57, 58
OEM Style Caps 59
Terminals
Butt Connectors 26, 27
Non-Insulated Solderless 28
Nylon Terminals 25
Premium Nylon Double Crimp 22
Solderless Heat Shrink 21
Specialty Terminals 26
Weather Pack 30
Testers 116, 117, 118, 119, 120
TEW Wire 47
Thimble 76
Three Battery Stud-to-Power
Take Off Post 42
Three Battery Stud-to-Power
Take Off Stud 42
Three Battery Top Post-to-Power Take Off
Post 42
Tie Down 99
Tinned Welding Cable 35
Tools
Battery Maintenance 111
Circuit Tester 111
Filler Bulb 111
Filler Jug 111
Hydrometers 111
Pointer Style Hydrometer 111
Safety Glasses 111
Bench Mount Crimp Tool 105

Cable Crimpers 105
Quick Crimp 105
Cable Cutters 109
QuickCutter 250 & QuickCutter 500 109
Cable Strippers 108
QuickStrip 108
Cable Ties 110
Heat Guns 114
Butane Torch 115
Deflectors 114
Flameless Heat Gun 115
Pneumatic Crimp Tool 107
Brute Hammer Crimper 106
Cub Crimper 106
Service Parts for Crimpers 106
Primary Wire 109
Cutter/Stripper with Pliers 109
Electrician's Automatic Wire Stripper 110
Heavy Duty Cutter/Crimper 109
Heavy Duty Ratchet Crimpers 110
Standard Cutter/ Crimper Tool 109
Wire Loom Cutting Tool 110
Wire Stripper 110
Ratchet Crimp Tool 105
Solder, Flux and Paste 15
Top Post Cables 43
Top Post Rigid Battery Cap 59
Top Post-to-Power Take Off Post 42
Top Post-to-Side Terminal Cables 45
Top Post-to-Side Terminal Connectors 19
Trailer Cable 50
Truck Battery Box 93
Trunk Kits 51
Tube Kits 56

U

UL Marine Battery Cable 34
UL Marine Primary Wire 48
Universal Leadheads 79

V

Vehicle Starter Kits 149
Vent Caps 89

W

Washers 137
Wash Water Treatment 140
Watermiser Vent Cap 89
Water Resistant ANL Fuse Holder 84
Water Sensor 90
Weather Pack 30
Weatherproof 300 SB Amp Connector 68
Welding Cable 35
Wire
Continuous Loop 51
Jacketed Marine Wire 48
Machine Tool Wire 36
Multi-Conductor Flat Jacketed 48
Parallel Bonded 49
Primary Wire 47
GPT General Purpose 47
SXL Cross-Linked Polyethylene 47
TEW 47
UL Marine Primary 48
Trunk Kits 51
Wire Connectors 89
Wire Loom Cutting Tool 110
Wire Solder 16

Wire Stripper 110

X

XCPR0-80 122
XTC-160 123

Powerful Online Resources for Product Information, Training, and Customer Ordering

QUICKCABLE.COM



At quickcable.com you'll find a complete interactive online catalog of all products. It's where you'll find the most up-to-date information on new products and applications. And if you are a registered user, you can order products directly online. There are also extensive resources including instruction manuals, MSDS and RoHS safety sheets as well as catalogs or market-specific applications.

QUICKHOWTO.COM



This extensive video library offers more than 100 video training programs on product usage, safety, selection, installation, and more. Whether you're looking for information on specific products and applications or managing a training program for your employees, this extensive library is yours to use 24/7 at no charge. It's the added value you get with QuickCable.

QUICK FIGURATOR



We make it easy for registered users to create cable drawings and specifications using online tools and submit them for quoting and production. Create anything from heavy-duty cables to braided ground straps and everything in-between! Most items are quoted in the same day and we give you a blue print plus bill of materials, in order to insure you get the information and products you need, quickly and conveniently.

KIT FIGURATOR

Our Kit Figurator makes ordering custom kits quick with our 2-step online ordering process and instant quote! There are vast options to choose from to choose the components that best fit your applications. Your configuration is stored online for reorder, replenish your kit components with ease. Receive your instant online kit quotation today!



LUG FINDER

With close to 400 different styles of lugs in stock, Quick Cable has made it easier to find what you need. Find lugs based on gauge size, style, hole size and angle. Streamline your search by picking attribute(s) you need.



QUICKCABLE®

PROVIDING A VARIETY OF HIGH QUALITY PRODUCTS



**CONNECTORS
& TERMINALS**



**WIRE
& CABLE**



**CABLE
MANAGEMENT**



**MATERIAL
HANDLING**



ACCESSORIES



**BATTERY
BOXES**



**TOOLS, TESTERS
& CHARGERS**



POWER PACKS



**SAFETY &
CHEMICALS**



KITS