

Cyclon®

MAGNACHARGE BATTERY

SINCE 1964





Canada

+1 (888) 271-8888
sales@magnacharge.com

United States

+1 (844) 370-0258
sales@magnacharge.com

Panama

+011 (507) 209-4776
info@magnachargepa.com

www.MAGNACHARGE.com

Cyclon®

**Wherever the world
needs stored energy,
EnerSys® is there.**

Powered by more than 100 years of expertise, EnerSys® is the world's largest industrial battery manufacturer, operating 21 facilities worldwide. Along with manufacturing and distributing a wide range of reserve power and motive power batteries, chargers, power equipment, and battery accessories, EnerSys provides unmatched aftermarket and customer support to its customers in over 100 countries worldwide.



The EnerSys® plant in Warrensburg, Missouri covers 32,000 square feet and is situated on 33 acres.

EnerSys® Value-Added Services

In addition to our manufacturing capability, EnerSys® is proud to provide its customers with the following services:

- Customized manufacturing design
- Battery recycling
- Online technical information
- Charging support
- Product testing
- On-site technical seminars
- Battery samples
- Application engineering
- Technical documentation
- Charger evaluation to determine compatibility with CYCLON® batteries

Applications

Batteries from the EnerSys “pure lead” family are used in a wide variety of standby and portable/cyclic applications including those in:

- Telecommunications
- Electronics
- Uninterruptible power supplies
- Defense installations
- Aviation (may require FAA or other appropriate agency certification/approval for installation in aircraft)
- Computer back-up
- Electric vehicles
- Medical equipment
- Solar power
- Lawn and garden equipment
- Extreme temperature environments (-65°C to +80°C or -85°F to +176°F) for single cells

Cyclon

CYCLON® BATTERY SELECTION GUIDE

TABLE OF CONTENTS

Company background

EnerSys®	2
Services and applications	2
Features and benefits	5

Technical information

Capacity as a function of temperature	7
State of charge	7
Storage time as a function of temperature	7
Charging recommendations	7

CYCLON® Battery Single Cells

CYCLON® product family	8
CYCLON® battery alternate configurations	9
CYCLON® battery standard descriptions	9
CYCLON® battery Single Cell performance specifications	10
CYCLON® battery Single Cell standard assemblies	11
CYCLON® battery BC Single Cell performance specifications	12
CYCLON® battery Single Cell mechanical specifications	13
CYCLON® battery BC Single Cell mechanical specifications	13
CYCLON® battery Single Cell constant current (CC) and constant power (CP) discharge graphs	14

CYCLON® Battery Monobloc

4V/6V Monobloc performance specifications	15
4V/6V Monobloc standard assemblies	16
4V/6V Monobloc mechanical specifications	17
4V/6V Monobloc constant current (CC) and constant power (CP) discharge graphs	18

Quick reference list

Standard product listing	19
--------------------------------	----



Powerful design

Resealable safety valve

A 50-PSI vent lets gases escape, then automatically reseals, so there's no risk of excessive gas accumulation within the battery, or "dry out" failure from repeated recharges.

Pure lead plates

Made from 99.99% pure lead, CYCLON® battery plates are extremely thin, so they offer more surface area than conventional batteries – and far more power.

AGM plate separator

High-purity acid is absorbed right into the Absorbed Glass Mat (AGM) plate separators, so the CYCLON battery provides leak-proof operation in any position.

Steel can enclosure

The CYCLON battery's metal outer jacket offers extreme shock, vibration, temperature, and flammability protection.

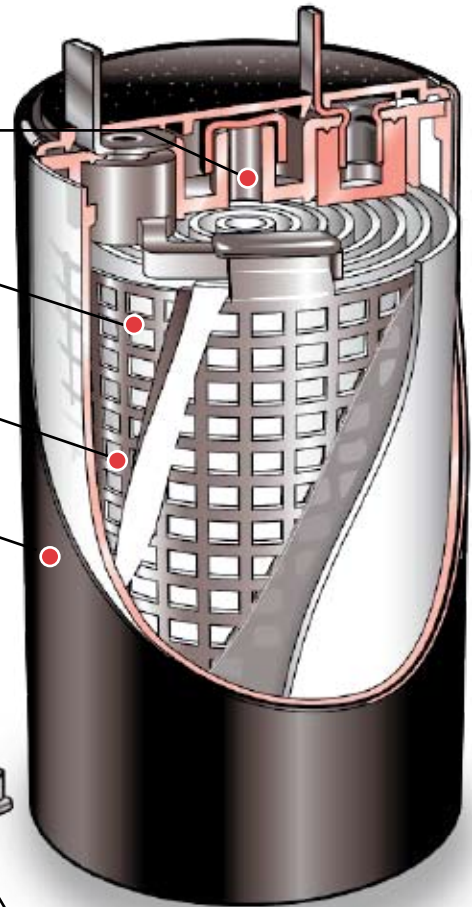

One-piece plastic cover

Direct thru-the-wall intercell connections

One-piece plastic case

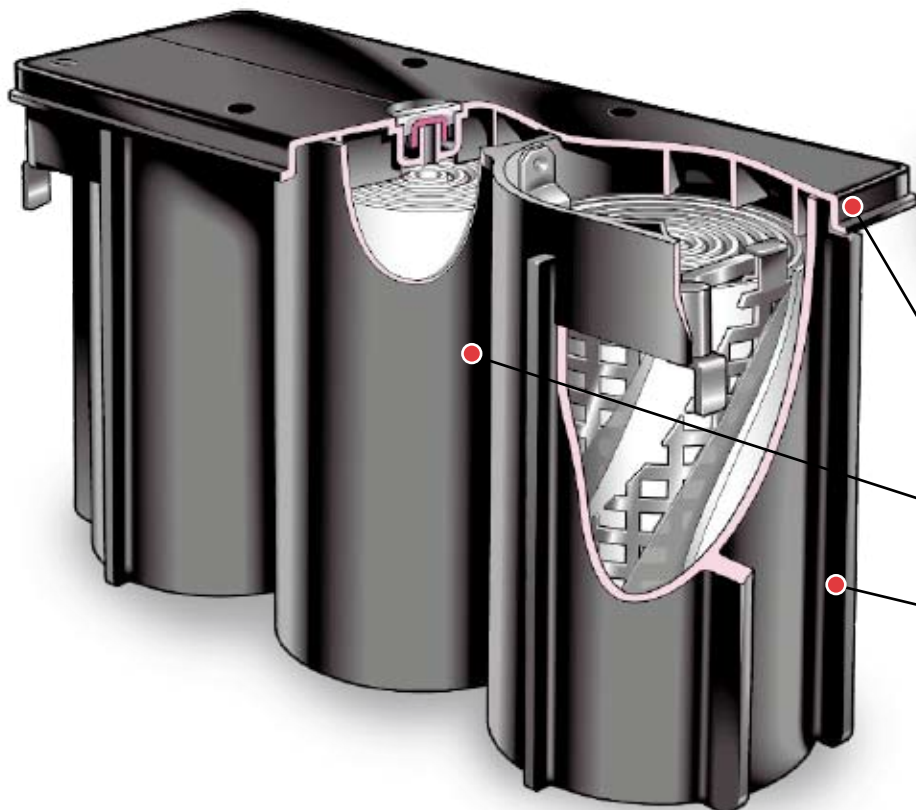

Features and Benefits

Sealed pure-lead cells were invented by the Gates Corporation in 1973. The purity of the materials used is key to supporting the CYCLON® battery's performance benefits. A longer service life, meaning fewer replacements and the cost associated with it, combined with higher reliability and fewer system failures, result in a lower long-term cost of ownership to the end user or equipment owner.

What are the advantages of EnerSys® technology?

- 1. Power density** - Per unit weight, the power provided by pure lead products offers the greatest high-rate power density for your energy dollar. CYCLON battery's greater volumetric power allows engineers to consider more energy-supporting features or design smaller, lighter packages.

At high-rate and pulse discharges, EnerSys® CYCLON batteries offer the best performance value when compared with competitive product in applications at less than 100 minutes of discharge.

- 2. Cycle life** - Compared to competitive lead products (offering up to 200 full cycles), pure lead batteries provide 50% to 200% greater full cycle capability. CYCLON batteries will deliver up to 300 cycles (100% DOD, C/5). And, because CYCLON batteries incorporate a high vent-pressure design, EnerSys products experience no "dry out" failure mode from repeated recharges.
- 3. Float life** - Conventional sealed-lead batteries vary greatly in specified standby life: from three to six years at 20°C, C/20. CYCLON battery Single Cells, however, offer a ten-year design life at 25°C, C/5, to 80% of rated capacity. At 20°C, CYCLON battery Single Cells offer a fifteen-year design life.
- 4. High stable voltage delivery** - The high stable voltage delivery of a pure lead battery results from its low internal resistance. The flat discharge voltage profile of our batteries, similar to nickel cadmium, combined with our products' low internal resistance, means our batteries are able to discharge and recharge their power more quickly and efficiently and offer greater application flexibility. The pure lead construction also gives more watts-per-unit weight at high discharge rates.

- 5. Safety** - Since CYCLON battery Single Cells and Monoblocs emit minimal to no gassing under normal charging conditions they are safe for installation in offices, aircraft cabins, hospitals or any other environment occupied by human beings. Underwriters Laboratories (UL) recognizes all CYCLON cells and batteries as components.

- 6. Widest temperature range** - Due to the products' strong construction and high vent pressures, these cells will maintain their performance and physical parameters in extreme conditions. At high temperatures, the chemical reaction in a battery that causes aging is accelerated. Pure lead technology resists that chemical reaction more effectively than alloyed lead, thus allowing a battery to have a longer service life. At high temperatures, when conventional lead batteries experience internal moisture loss from venting and case side wall distention, the CYCLON Single Cell battery, with its steel can (jacket) and 50psi vent, does not experience these life-robbing conditions. CYCLON batteries have twice the delivered capacity of conventional sealed-lead batteries at temperatures below -20°C, offering unparalleled low-temperature performance.

Our batteries have thinner plates, and therefore greater plate surface area than conventional sealed-lead, thick plate batteries. As a result our batteries can reach a high state of charge in fast-charging applications in one-fourth the time of conventional, sealed-lead, thick-plate batteries. This is 50% to 100% overall better performance for your energy dollar.

- 7. Rugged construction** - Due to their strong external packaging and internal pure lead composition, EnerSys products can withstand not only extreme temperatures but also harsh usage.

CYCLON battery Single Cells are available housed in cases constructed of UL 94V-0 rated material. The CYCLON battery Single Cell itself is in a metal jacket giving added flammability protection. CYCLON batteries are shock and vibration resistant, designed to offer higher tolerance levels to meet demanding applications, including those in commercial and outdoor applications. The company's focus on battery-case integrity and high vent pressure, coupled with pure lead's low grid-corrosion rate, means CYCLON battery cells and Monoblocs provide the longest service life possible.

CYCLON® Battery Single Cell/Monobloc comparison chart

	Design	Construction	Operating range	Voltages
Single Cells	3 atm venting pressure	Metal outer case & spiral construction	-65°C to +80°C	2 volt cells
Monobloc	0.5 atm venting pressure	Plastic outer case & spiral construction	-40°C to +40°C	4 & 6 volt units

The pure lead advantage

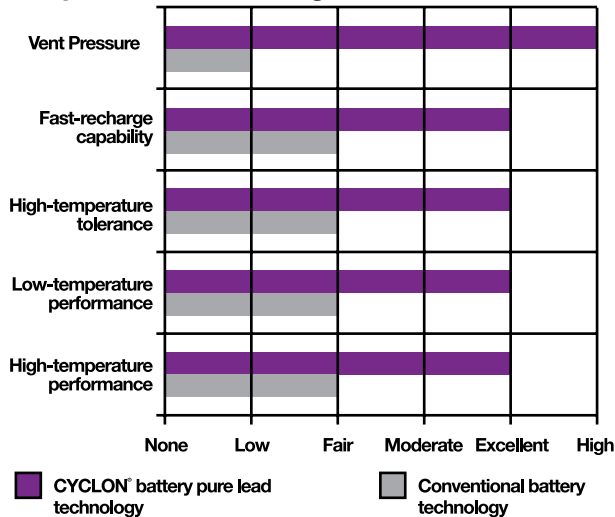

Each plastic Monobloc consists of Single Cell elements, internally connected to provide a 4 or 6 volt unit. Monoblocs or Single Cells can be connected in series or parallel to achieve the required voltage or capacity. Monoblocs and Single Cells are supplied with spade terminals making electrical connections quick and easy. Additionally, EnerSys® products offer the highest vent pressure in the market. As a result, our batteries are more resistant to venting and dryout from continuous overcharge in standby applications.

- 8. Fastest recharge** - EnerSys pure lead chemistry allows our batteries and cells to offer the highest recharge efficiency of any sealed-lead battery on the market. With pure lead, you can achieve a 95% state of recharge in less than one hour - without loss of capacity or electrolyte using conventional constant-voltage charging techniques.

Flexible charging options are possible with CYCLON® battery Single Cells and Monoblocs, as no current limit is required when using a constant voltage charger.

- 9. Orientation/placement/transport** - Due to the products' mechanical design, CYCLON batteries can be mounted and operated in any position, an attractive feature for less accessible areas.

CYCLON battery Single Cells offer UL 94V-0 flame-retardant packaging, thus allowing the mounting of systems in sensitive areas and human environments. Plus, the unique and flexible 2-volt CYCLON battery Single Cell allows you to design your system using an almost infinite number of packaging/design configurations.

Effective September 30, 1995, CYCLON battery Single Cells and Monoblocs were classified as "nonspillable batteries", and are excepted from the Department of Transportation's comprehensive packaging requirements if the following conditions are satisfied: (1) The battery is protected against short circuits and is securely packaged and (2) The battery and outer packaging must be plainly and durably marked "NONSPILLABLE" or "NONSPILLABLE BATTERY". CYCLON battery shipments from the EnerSys plant in Warrensburg, Missouri will be properly labeled in accordance with applicable regulations. Packaging changes performed at other locations may require additional labeling, since in addition to the battery itself containing the required marking, the outer packaging of the battery must also contain the required marking: "NONSPILLABLE" or "NONSPILLABLE BATTERY".

CYCLON battery Single Cells and Monoblocs have been tested and determined to be in compliance with the vibration and pressure differential tests contained in 49 CFR § 173.159(d).

Because CYCLON battery Single Cells and Monoblocs are classified as "Nonspillable" and meet the conditions above, [from § 173.159(d)] they do not have an assigned UN number nor do they require additional DOT hazard labeling.

The regulation change effective September 1995, was to clarify and distinguish to shippers and transporters, all batteries that have been tested and determined to be in compliance with the DOT Hazardous Material Regulations, the International Civil Aeronautics Organization (ICAO), and the International Air Transport Association (IATA) Packaging Instruction 806 and Special Provision A67, and therefore excepted from all other requirements of these regulations and classified as a "nonspillable battery".

- 10. Shelf life** - Pure lead batteries have an extremely low self-discharge rate, thus providing extended storage capability while maintaining high state-of-charge levels for dependable operation.

CYCLON battery Single Cells and Monoblocs have a shelf life more than two times that of conventional lead batteries. To assure maximum reliability, EnerSys recommends that all stored cells/batteries be recharged (boost charged) once every 24 months or when the open circuit voltage drops to 2.00 volts per cell, whichever occurs earlier. Inventory should be checked more frequently if storage temperature regularly exceeds 25°C.

Capacity as a function of temperature for CYCLON® Battery Single Cells & Monoblocs (use graph up to 40°C for Monoblocs)

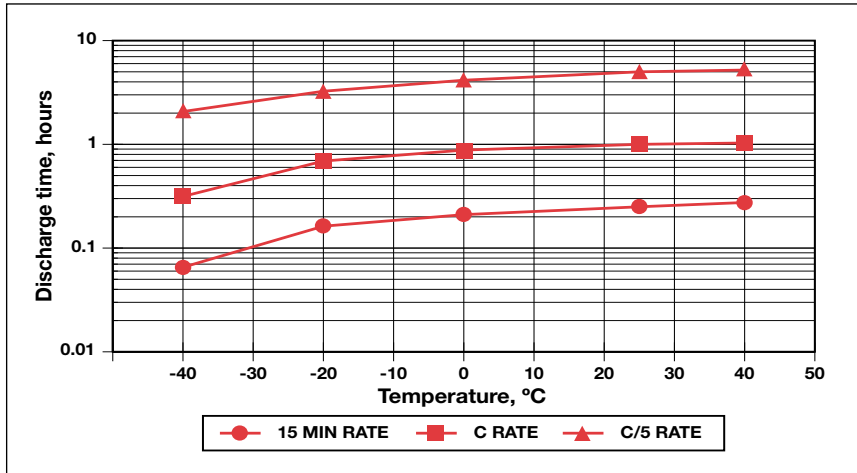

State of charge for CYCLON® Battery Single Cells & Monoblocs

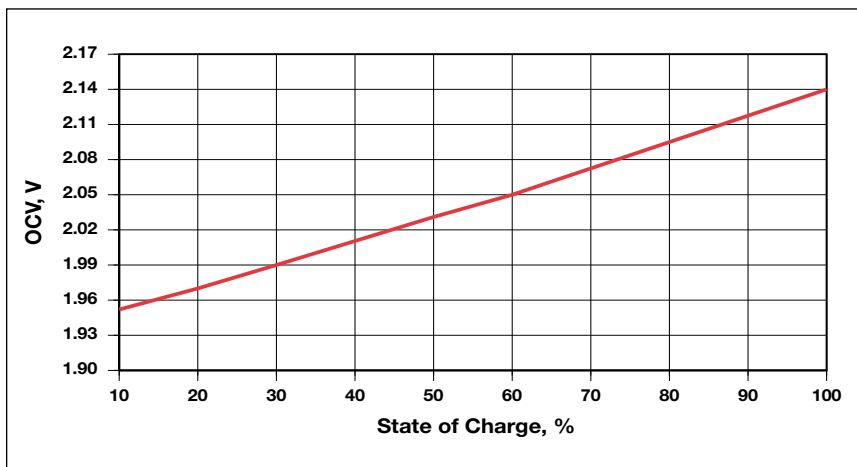

Storage time as a function of temperature for CYCLON® Battery Single Cells & Monoblocs (fully charged cell)

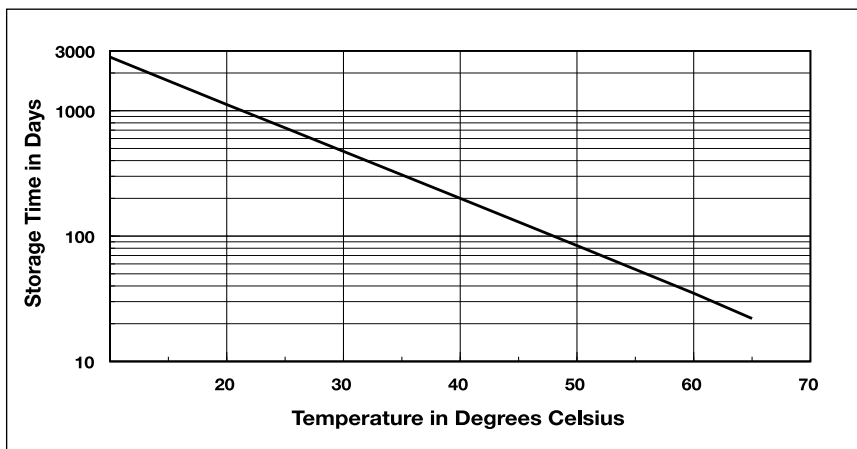

Charging recommendations:

Broadly speaking, a battery may be recharged using either a constant voltage (CV) charger or a constant current (CC) charger, or a modification of either or both of these.

The exact regime chosen generally depends upon the time and economic constraints imposed by the system. Constant current charging is widely used in cyclic applications where a recharge must be accomplished in a relatively short time period. Constant voltage charging, where a single voltage level is applied across the battery terminals, is the most suitable method to recharge CYCLON® batteries. Depending on the CV charger's current limit, it is possible to recharge these batteries from a 100% discharged condition to better than 95% state of charge in less than one hour, using only the cyclic charge voltage.

Constant voltage charging

Constant voltage (CV) charging should be within the following ranges:

Fast Chargers, Per cell:

2.45 to 2.50 volts @ 25°C

12 volts:

14.70 to 15.0 volts @ 25°C
(for a maximum of 16-20 hours)

Float Chargers, Per cell:

2.27 to 2.35 volts @ 25°C

12 volts:

13.62 to 14.10 volts @ 25°C

To avoid thermal runaway in warmer temperatures, and to improve charge acceptance in colder temperatures, the charger voltage should be compensated by approximately 3 millivolts per cell per degree Centigrade variance from 25°C. This is a negative coefficient, with the voltage being lowered as the temperature increases, and vice versa.

There is no need to limit the inrush current to the battery during constant voltage charging. The low internal resistance of EnerSys® CYCLON® battery Single Cells and Monoblocs allows for large inrush current without damage.

Since not all of the charge returned is accepted to replenish the electro-chemical potential, a good rule of thumb to use is that the charge returned should be 105% to 110% of the capacity delivered on the previous discharge.

Most current waveforms are not pure DC nor are they pure sine waves. Therefore, consult the EnerSys Application Support Department for assistance when evaluating the charger current waveforms for your specific application.

A three-step 6-8 hour charge profile optimized for CYCLON cells and batteries is available on request from the Technical Support Department of EnerSys.

CYCLON® Battery Product Family (All capacities at 10 hr. rate 25°C to 1.67Vpc)

CYCLON® Battery 2V Single Cell:

Products	Capacity	Part Number	Internal res. of fully charged cell mΩ @ 25°C	Nominal short circuit current for charged cell	Diameter		DIMENSIONS							
							in.	mm	Height in.	mm	Height with terminals in.	mm	Weight oz.	gm
D cell	2.5Ah	0810-0004	5.0	400A	1.35	34.3	2.41	61.2	2.68	68.1	6.28	178.0	.187x.025	4.75x0.64
DT cell	4.5Ah	0860-0004	5.0	400A	1.35	34.3	3.78	96.0	4.05	102.9	9.68	274.4	.187x.025	4.75x0.64
X cell	5.0Ah	0800-0004	3.5	570A	1.75	44.5	2.87	72.9	3.21	81.5	12.77	362.0	.250x.025	6.35x0.64
E cell	8.0Ah	0850-0004	3.0	665A	1.75	44.5	3.94	100.1	4.28	108.7	17.28	489.9	.250x.025	6.35x0.64
J cell	12.0Ah	0840-0004	2.5	800A	2.04	51.8	4.85	123.2	5.34	135.6	29.60	839.2	.312x.032	7.92x0.81
BC cell	25Ah	0820-0004	1.5	1335A	2.57	65.3	6.25	158.8	6.82	173.2	58.88	1669.2	M6 (-) and M8 (+) terminals	

CYCLON® Battery 4V Monoblocs:

Products	Capacity	Part Number	Internal res. of fully charged Monobloc mΩ @ 25°C	Nominal short circuit current for charged cell	Diameter		DIMENSIONS							
							in.	mm	Height in.	mm	Height with terminals in.	mm	Weight oz.	gm
D cell	2.5Ah	0819-0010	10.0	400A	3.13	79.5	1.81	46.0	2.75	69.9	.80	.36	.187x.025	4.75x0.64
X cell	5.0Ah	0809-0010	7.0	570A	3.80	96.5	2.12	53.8	3.02	76.7	1.62	.74	.250x.025	6.35x0.64
E cell	8.0Ah	0859-0010	6.0	665A	3.81	96.8	2.13	54.1	4.00	101.6	2.11	.96	.250x0.25	6.35x0.64

CYCLON® Battery 6V Monoblocs:

Products	Capacity	Part Number	Internal res. of fully charged Monobloc mΩ @ 25°C	Nominal short circuit current for charged cell	Length		DIMENSIONS							
							in.	mm	Width in.	mm	Height in.	mm	Weight lb.	kg
D cell	2.5Ah	0819-0012	15.0	400A	4.48	113.8	1.81	46.0	2.75	69.9	1.15	.52	.187x.025	4.75x0.64
X cell	5.0Ah	0809-0012	10.0	570A	5.48	139.2	2.12	53.8	3.02	76.7	2.16	.98	.250x0.25	6.35x0.64
E cell	8.0Ah	0859-0012	8.0	665A	5.48	139.2	2.13	54.1	4.00	101.6	3.15	1.43	.250x0.25	6.35x0.64

CYCLON® Battery Single Cell

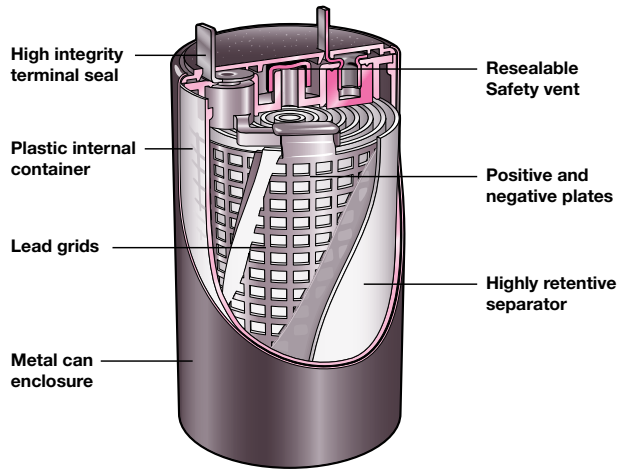

Alternative battery configurations

Standard battery configurations are rectangular in overall shape. A sample of other possible configurations are illustrated below. These can be held together with tape (offering the lowest cost and minimum electrical and mechanical protection) or by shrink wrapping. The CYCLON® battery Single Cell can be custom configured in virtually an infinite number of designs.

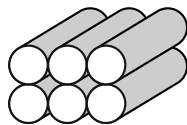

Rectangular

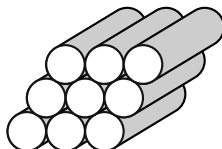

Rhomboid

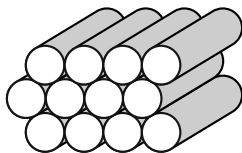

Nested

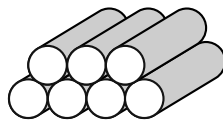

Trapezoid

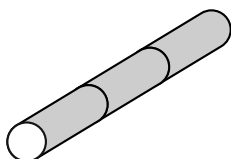

Tubular

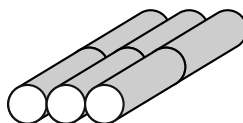

Flat Pack

CYCLON® battery standard descriptions

CYCLON battery cells are ideal for small ampere-hour applications up to 25Ah. The sealed-lead construction uses a starved-electrolyte system and a patented grid-alloy providing numerous advantages.

Standard batteries are offered based on combinations of the previously described CYCLON battery cells and are available in 6 and 12 volt configurations with capacities ranging from 2.5Ah to 25Ah.

Battery Packages

Rigid plastic cases or shrink wrap packaging are available.

Rigid Plastic

Cases are available for most designs in either flame-retardant ABS material, meeting UL 94V-0 flammability rating, or Styrene (available only in 2X3 D and X battery configurations). Some cases have mounting holes. Rigid plastic cases are recommended for applications in which the battery must withstand vibration, movement or extreme weather conditions.

Shrink Wrap

Shrink wrap packaging is less expensive and smaller in size and weight. A plastic extrusion insulates the battery top and keeps the cells in line. A heavy duty shrink sleeve holds the cells firmly in place. Shrink wrap packaging is recommended for applications in which the battery remains stationary.

Battery Terminations for Single Cell and Monoblocs

Tab/Stud

Cell size	Dimensions
D	.187" x .025"
DT	.187" x .025"
X	.250" x .025"
E	.250" x .025"
J	.312" x .032"
BC	6mm post (negative) 8mm post (positive)

Tab Adapters (D, DT, X, and E)

Available to convert .187" tabs to .250" tabs, 0.032" thick, and vice versa.

BC Quick Disconnect Terminals

AMP series 250 Faston terminals are available for BC batteries.

Connection Terminations

A wide variety of terminations are offered. For recommendations or to specify; contact your EnerSys® Territory Manager or battery assembler.

Fusible Links

Specify your requirement.

Lead Wires

Stranded copper wire with insulation meeting UL1015 specifications (Red +, Black -). Standard leads extend 9 inches outside the battery pack. Ends are stripped and dipped in wax, which must be removed before use.

Standard wire gauges are:

D batteries	18AWG, UL1015
DT batteries	16AWG, UL1015
X batteries	16AWG, UL1015
E batteries	14AWG, UL1015
J batteries	14AWG, UL1015
BC batteries	12AWG, UL1015

Varying lead lengths and gauges are also available; please specify to your EnerSys® Territory Manager or battery assembler.

Intercell Connections

Standard

D, DT, X and E batteries—welded tin-plated steel connector

J batteries—soldered, stranded wire

BC batteries—solid copper

For vibration-prone applications

D, DT, X, E and J batteries—soldered, stranded wire

BC batteries—braided copper straps

CYCLON® Battery Single Cell performance specifications

Constant current discharge/amps to 1.67Vpc @ 25°C

Products	DURATION									
	5 min	10 min	15 min	30 min	60 min	90 min	5 hr	8 hr	10 hr	20 hr
D cell (2.5Ah)	14.8	8.1	5.9	3.4	1.9	1.4	.48	.32	.26	.13
DT cell (4.5Ah)	25.2	15.0	11.2	6.6	3.7	2.6	.85	.55	.45	.24
X cell (5.0Ah)	27.3	17.8	13.2	7.0	3.9	2.8	.96	.61	.50	.26
E cell (8.0Ah)	41.7	26.4	19.0	11.0	6.2	4.4	1.6	1.0	.81	.42
J cell (12.0Ah)	51.7	38.1	29.4	18.0	9.2	6.5	2.3	1.5	1.20	.66

Constant power discharge/watts per cell to 1.67Vpc @ 25°C

Products	DURATION									
	5 min	10 min	15 min	30 min	60 min	90 min	5 hr	8 hr	10 hr	20 hr
D cell (2.5Ah)	26.4	16.1	11.6	6.7	3.8	2.7	.94	.61	.50	.25
DT cell (4.5Ah)	45.0	28.1	21.0	12.5	7.1	5.1	1.7	1.1	.90	.46
X cell (5.0Ah)	45.4	31.9	23.9	13.9	7.8	5.6	1.9	1.2	1.0	.51
E cell (8.0Ah)	77.8	51.0	35.5	21.1	12.4	8.9	3.1	2.0	1.6	.85
J cell (12.0Ah)	90.4	68.4	53.4	31.6	18.3	13.2	4.7	3.0	2.3	1.3

Charging/Temperature/Life:

Products	CHARGING PER CELL		TEMPERATURE RANGE		LIFE EXPECTANCY	
	Cyclic	Float	Storage & discharge	Charge	C/5 Cycle life 100% DOD	Float life at 25°C (20°C)
D, DT, X, E & J cell	CV 2.45-2.50 CC*	CV 2.27-2.35 CC*	-65°C to +80°C	-40°C to -80°C	300	10 years (15 years)

Maximum recommended storage time before recharge - 24 months @ 25°C or 2.0Vpc, whichever is earlier

Atmospheric pressure range - Vacuum to 8 atmospheres

*Users planning to use CC should consult the EnerSys® Application Support Department.

UL Recognized Component. Meets UL 1989

Caution: Batteries contain toxic materials (Pb and H2SO4) • Avoid short circuit • Do not charge in gas-tight container

Sealed-lead rechargeable battery must be recycled or disposed of properly. Contact EnerSys® Customer Service for details.



CYCLON® Battery Single Cell standard assemblies

CYCLON® Battery 6 Volt 1x3 Shrink Wrap

Product Number	Description	Length		Width		Height		Weight		Leads
		in.	mm	in.	mm	in.	mm	lbs.	kg	
0810-0102	2.5Ah D Dbl. Slot	4.05	102.9	1.48	37.6	2.66	67.6	1.23	.56	No
0810-0103	2.5Ah D	4.05	102.9	1.48	37.6	2.66	67.6	1.25	.57	Yes
0860-0102	4.5Ah DT Dbl. Slot	4.05	102.9	1.48	37.6	4.03	102.4	2.07	.94	No
0860-0103	4.5Ah DT	4.05	102.9	1.48	37.6	4.03	102.4	2.09	.95	Yes
0800-0102	5.0Ah X Dbl. Slot	5.25	133.4	1.87	47.5	3.12	79.2	2.48	1.13	No
0800-0103	5.0Ah X	5.25	133.4	1.87	47.5	3.12	79.2	2.52	1.14	Yes
0850-0102	8.0Ah E Dbl. Slot	5.25	133.4	1.87	47.5	4.19	106.4	3.49	1.58	No
0850-0103	8.0Ah E	5.25	133.4	1.87	47.5	4.19	106.4	3.53	1.60	Yes



CYCLON® Battery 6 Volt 1x3 ABS Case

Product Number	Description	Length		Width		Height		Weight		Leads
		in.	mm	in.	mm	in.	mm	lbs.	kg	
0810-0011	2.5Ah D Dbl. Slot	4.23	107.4	1.55	39.4	2.75	69.9	1.33	.60	No
0810-0077	2.5Ah D Sing. Slot	4.23	107.4	1.55	39.4	2.75	69.9	1.37	.62	Yes
0800-0011	5.0Ah X Dbl. Slot	5.44	138.2	1.96	49.8	3.16	80.3	2.71	1.23	No
0800-0071	5.0Ah X Sing. Slot	5.44	138.2	1.96	49.8	3.16	80.3	2.74	1.24	Yes



CYCLON® Battery 12 Volt 2x3 Shrink Wrap

Product Number	Description	Length		Width		Height		Weight		Leads
		in.	mm	in.	mm	in.	mm	lbs.	kg	
0810-0114	2.5Ah D Dbl. Slot	4.05	102.9	2.82	71.6	2.67	67.8	2.48	1.13	No
0810-0115	2.5Ah D	4.05	102.9	2.82	71.6	2.67	67.8	2.50	1.14	Yes
0860-0114	4.5Ah DT Dbl. Slot	4.05	102.9	2.82	71.6	4.03	102.4	3.88	1.76	No
0860-0115	4.5Ah DT	4.05	102.9	2.82	71.6	4.03	102.4	3.91	1.77	Yes
0800-0114	5.0Ah X Dbl. Slot	5.25	133.4	3.68	93.5	3.13	79.5	4.93	2.24	No
0800-0115	5.0Ah X	5.25	133.4	3.68	93.5	3.13	79.5	4.97	2.26	Yes
0850-0114	8.0Ah E Dbl. Slot	5.25	133.4	3.68	93.5	4.19	106.4	6.73	3.05	No
0850-0115	8.0Ah E	5.25	133.4	3.68	93.5	4.19	106.4	6.77	3.07	Yes



CYCLON® Battery 12 Volt 2x3 ABS and Styrene Cases

Product Number	Description	Length		Width		Height		Weight		Leads
		in.	mm	in.	mm	in.	mm	lbs.	kg	
0810-0008	2.5Ah D Dbl. Slot	4.23	107.4	2.88	73.2	2.72	69.1	2.68	1.22	No
0810-0067*	2.5Ah D (Styrene)	4.23	107.4	2.97	75.4	2.73	69.3	2.63	1.19	Yes
0800-0008	5.0Ah X Dbl. Slot	5.44	138.2	3.70	94.0	3.14	79.8	5.34	2.42	No
0800-0047*	5.0Ah X (Styrene)	5.44	138.2	3.70	94.0	3.19	81.0	5.22	2.37	Yes



CYCLON® Battery 12 Volt 1x6 Shrink Wrap

Product Number	Description	Length		Width		Height		Weight		Leads
		in.	mm	in.	mm	in.	mm	lbs.	kg	
0810-0108	2.5Ah D Dbl. Slot	8.08	205.2	1.48	37.6	2.66	67.6	2.49	1.13	No
0810-0109	2.5Ah D	8.08	205.2	1.48	37.6	2.66	67.6	2.52	1.14	Yes
0860-0108	4.5Ah DT Dbl. Slot	8.08	205.2	1.48	37.6	4.03	102.4	3.88	1.76	No
0860-0109	4.5Ah DT	8.08	205.2	1.48	37.6	4.03	102.4	3.91	1.77	Yes
0800-0108	5.0Ah X Dbl. Slot	10.48	266.2	1.87	47.5	3.12	79.2	4.99	2.27	No
0800-0109	5.0Ah X	10.48	266.2	1.87	47.5	3.12	79.2	5.03	2.28	Yes
0850-0108	8.0Ah E Dbl. Slot	10.48	266.2	1.87	47.5	4.19	106.4	6.73	3.05	No
0850-0109	8.0Ah E	10.48	266.2	1.87	47.5	4.19	106.4	6.77	3.07	Yes



CYCLON® Battery 12 Volt 1x6 ABS Case

Product Number	Description	Length		Width		Height		Weight		Leads
		in.	mm	in.	mm	in.	mm	lbs.	kg	
0810-0016	2.5Ah D Dbl. Slot	8.25	209.6	1.55	39.4	2.74	69.6	2.74	1.24	No
0810-0075	2.5Ah D Sing. Slot	8.25	209.6	1.55	39.4	2.74	69.6	2.76	1.25	Yes
0800-0016	5.0Ah X Dbl. Slot	10.66	270.8	1.96	49.8	3.15	80.0	5.20	2.36	No
0800-0072	5.0Ah X Sing. Slot	10.66	270.8	1.96	49.8	3.15	80.0	5.24	2.38	Yes

All dimensions, excluding weight, are maximum

*Due to special assembly, consult the EnerSys® Customer Service Department for availability.

CYCLON® Battery BC Single Cell performance specifications

Constant current discharge/amps to 1.67Vpc @ 25°C

Products	DURATION									
	5 min	10 min	15 min	30 min	60 min	90 min	5 hr	8 hr	10 hr	20 hr
BC cell (2.5Ah)	118.3	72.8	54.3	32.2	19.3	14.0	4.85	3.14	2.55	1.33

Constant current discharge/watts per cell to 1.67Vpc @ 25°C

Products	DURATION									
	5 min	10 min	15 min	30 min	60 min	90 min	5 hr	8 hr	10 hr	20 hr
BC cell (2.5Ah)	197.3	142.4	105.5	63.5	36.8	25.6	9.20	6.04	4.95	2.60

Charging/Temperature/Life:

Products	CHARGING PER CELL		TEMPERATURE RANGE		LIFE EXPECTANCY	
	Cyclic	Float	Storage & discharge	Charge	C/5 Cycle life 100% DOD	Float life at 25°C (20°C)
BC cell (2.5Ah)	CV 2.45-2.50 CC*	CV 2.27-2.35 CC*	-65°C to +80°C	-40°C to -80°C	300	10 years (15 years)

Maximum recommended storage time before recharge - 24 months @ 25°C or 2.0Vpc, whichever is earlier

Atmospheric pressure range - Vacuum to 8 atmospheres

Mounting - Terminal torque must not exceed 35 in-lbs. (3.95 Nm)

*Users planning to use CC should consult the EnerSys® Application Support Department



CYCLON® Battery 12 Volt 2x3 25.0Ah Case

Product Number	Description	Length		Width		Height		Weight		Leads
		in.	mm	in.	mm	in.	mm	lbs.	kg	
0820-2018	BC Double Slot, Copper Straps	8.05	204.5	5.45	138.4	7.25	184.2	22.86	10.4	Yes
0820-0020	BC Double Slot, Copper Straps	8.05	204.5	5.45	138.4	7.25	184.2	22.86	10.4	No

All dimensions, excluding weight, are maximum

UL Recognized Component. Meets UL 1989

Caution: Batteries contain toxic materials (Pb and H2SO4) • Avoid short circuit • Do not charge in gas-tight container

Sealed-lead rechargeable battery must be recycled or disposed of properly. Contact EnerSys® Customer Service for details.

CYCLON® Battery Single Cell mechanical specifications (E, G, H & J - Maximum)

Products	DIMENSIONS												Weight lb. kg	
	A in. mm	B in. mm	C in. mm	D	E in. mm	F in. mm	G in. mm	H in. mm	I in. mm	J in. mm				
D cell	0.27 6.9	0.51 13.0	0.187 4.75	22°	0.27 6.9	0.025 0.64	2.41 61.2	0.05 1.3	0.13 3.3	1.35 34.3	6.28 178.0			
DT cell	0.27 6.9	0.51 13.0	0.187 4.75	22°	0.27 6.9	0.025 0.64	3.78 96.0	0.05 1.3	0.13 3.3	1.35 34.3	9.68 274.4			
X cell	0.29 7.4	0.61 15.5	0.250 6.35	22°	0.34 8.6	0.025 0.64	2.87 72.9	0.06 1.5	0.14 3.6	1.75 44.5	12.77 362.0			
E cell	0.29 7.4	0.61 15.5	0.250 6.35	22°	0.34 8.6	0.025 0.64	3.94 100.1	0.06 1.5	0.14 3.6	1.75 44.5	17.28 489.9			
J cell	0.32 8.1	0.74 18.8	0.312 7.92	22°	0.49 12.4	0.032 0.81	4.85 123.2	0.05 1.3	0.15 3.8	2.04 51.8	29.60 839.2			

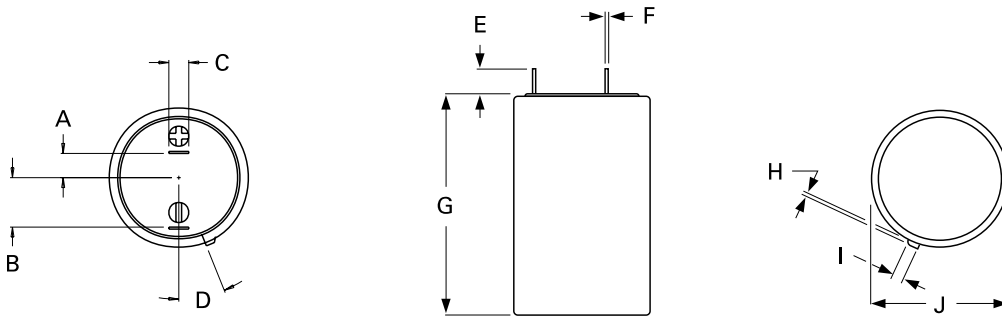

CYCLON® Battery BC Single Cell mechanical specifications (F, G & I - Maximum)

Products	DIMENSIONS										Weight lb. kg	
	A in. mm	B in. mm	C	D in. mm	E in. mm	F in. mm	G in. mm	H in. mm	I in. mm			
BC cell	0.65 16.5	1.30 33.0	22	0.57 14.5	0.22 5.6	6.25 158.8	0.06 1.5	0.13 3.3	2.57 65.3	3.68 1.67		

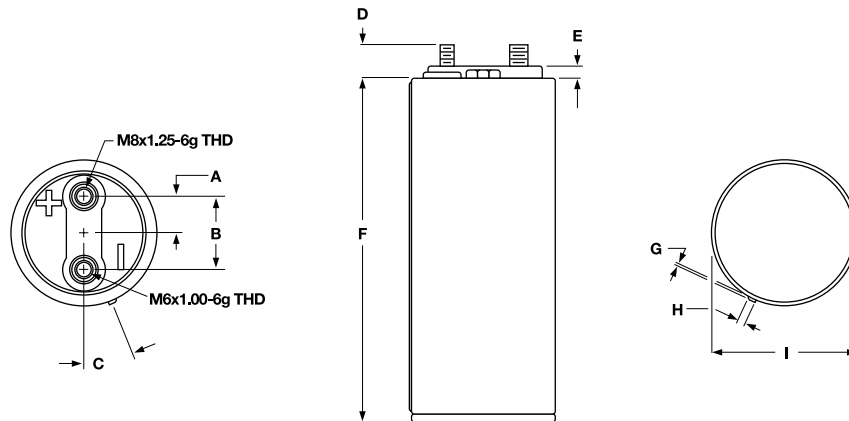

CYCLON® Battery Single Cell constant current (CC) discharge

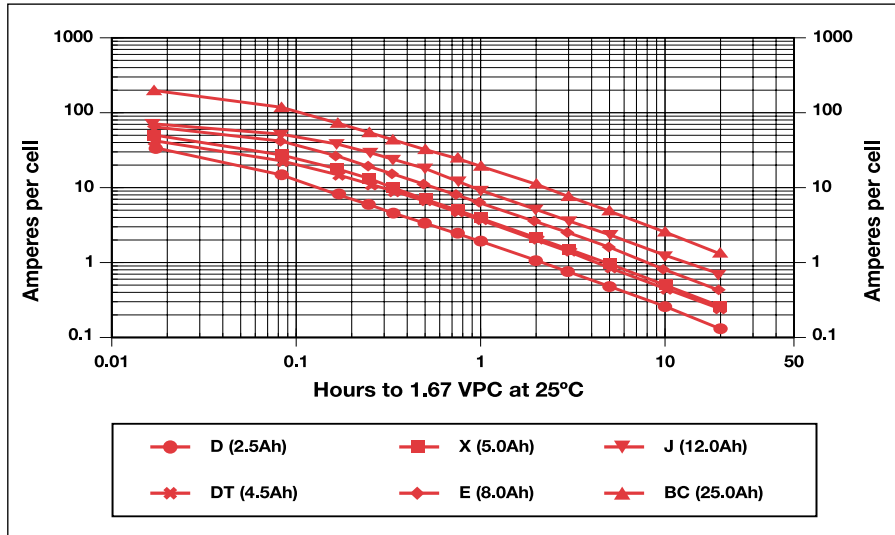

CYCLON® Battery Single Cell constant power (CP) discharge

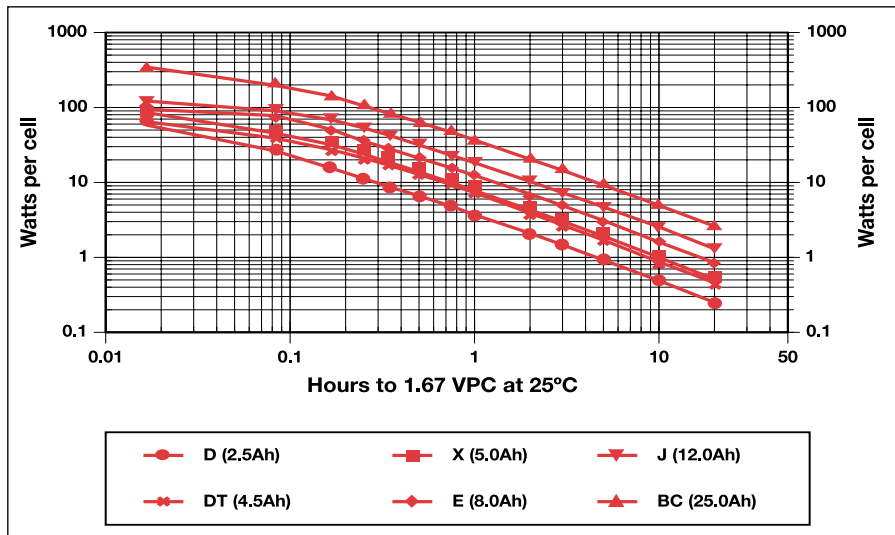

CYCLON® Battery 4V/6V Monobloc performance specifications

4V & 6V Constant current discharge/amps to 1.67Vpc @ 25°C

Products	DURATION									
	5 min	10 min	15 min	30 min	60 min	90 min	5 hr	8 hr	10 hr	20 hr
D cell (2.5Ah)	14.3	8.1	5.9	3.4	1.9	1.4	.48	.32	.26	.13
X cell (5.0Ah)	28.9	18.1	13.5	7.1	4.0	2.8	1.0	.61	.52	.26
E cell (8.0Ah)	41.7	26.4	19.0	11.0	6.2	4.4	1.6	1.0	.81	.42

4V & 6V Constant power discharge/watts per cell to 1.67Vpc @ 25°C

Products	DURATION									
	5 min	10 min	15 min	30 min	60 min	90 min	5 hr	8 hr	10 hr	20 hr
D cell (2.5Ah)	25.3	15.9	11.7	6.8	3.8	2.7	.93	.60	.49	.25
X cell (5.0Ah)	48.8	32.3	24.2	13.8	7.8	5.6	2.0	1.2	1.0	.52
E cell (8.0Ah)	77.8	51.0	35.5	21.1	12.4	8.9	3.1	2.0	1.7	.85

Charging/Temperature/Life

Products	CHARGING PER CELL		TEMPERATURE RANGE		LIFE EXPECTANCY	
	Cyclic	Float	Storage, discharge & charge	Safety pressure relief valve	C/5 Cycle life 100% DOD	Float life at 25°C (20°C)
4V D, X, & E Monobloc	CV 4.90-5.00 CC*	CV 4.54-4.70 CC*	-40°C to +40°C	8 psi	300	Up to 8 yrs (Up to 8 yrs)
6V D, X, & E Monobloc	CV 7.35-7.50 CC*	CV 6.81-7.05 CC*	-40°C to +40°C	8 psi	300	Up to 8 yrs (Up to 8 yrs)

Maximum recommended storage time before recharge - 24 months @ 25°C or 2.0Vpc, whichever is earlier

Atmospheric pressure range - Vacuum to 2 atmospheres

Mounting - Each Monobloc is equipped with mounting holes in the cover. The tightening torque for mounting the Monobloc is 25 in-lbs. When using 4 mounting bolts, small spacers (washers) 1 to 3 mm thick should be placed between the battery and the mounting surface to prevent bowing or stressing the battery case.

*Users planning to use CC should consult the EnerSys® Application Support Department.

UL Recognized Component. Meets UL 1989

Caution: Batteries contain toxic materials (Pb and H₂SO₄) • Avoid short circuit • Do not charge in gas-tight container

Sealed-lead rechargeable battery must be recycled or disposed of properly. Contact EnerSys® Customer Service for details.



CYCLON® Battery 4V/6V Monobloc standard assemblies

CYCLON® Battery 4 Volt Monoblocs

Product Number	Description	Length		Width		Height		Weight	
		in.	mm	in.	mm	in.	mm	lbs.	kg
0819-0010	4V, 2.5Ah Monobloc	3.13	79.5	1.81	46.0	2.75	69.9	.80	.36
0809-0010	4V, 5.0Ah Monobloc	3.80	96.5	2.12	53.8	3.02	76.7	1.62	.74
0859-0010	4V, 8.0Ah Monobloc	3.81	96.8	2.13	54.1	4.00	101.6	2.11	.96



CYCLON® Battery 6 Volt Monoblocs

Product Number	Description	Length		Width		Height		Weight	
		in.	mm	in.	mm	in.	mm	lbs.	kg
0819-0012	6V, 2.5Ah Monobloc	4.48	113.8	1.81	46.0	2.75	69.9	1.15	.52
0809-0012	6V, 5.0Ah Monobloc	5.48	139.2	2.12	53.8	3.02	76.7	2.16	.98
0859-0012	6V, 8.0Ah Monobloc	5.48	139.2	2.13	54.1	4.00	101.6	3.15	1.43



CYCLON® Battery 12 Volt 2x3 Monoblocs

Product Number	Description	Length		Width		Height		Weight	
		in.	mm	in.	mm	in.	mm	lbs.	kg
0819-0030	12V, 2.5Ah, 2x3	4.48	113.8	3.52	89.4	2.77	70.4	2.30	1.04
0809-0030	12V, 5.0Ah, 2x3	5.48	139.2	4.18	106.2	3.04	77.2	4.32	1.96
0859-0030	12V, 8.0Ah, 2x3	5.48	139.2	4.18	106.2	4.02	102.1	6.30	2.86



CYCLON® Battery 12 Volt 1x6 Monoblocs

Product Number	Description	Length		Width		Height		Weight	
		in.	mm	in.	mm	in.	mm	lbs.	kg
0819-0016	12V, 2.5Ah, 1x6	8.84	224.5	1.81	46.0	2.77	70.4	2.30	1.04
0809-0016	12V, 5.0Ah, 1x6	10.88	276.4	2.12	53.8	3.04	77.2	4.32	1.96
0859-0016	12V, 8.0Ah, 1x6	10.88	276.4	2.13	54.1	4.02	102.1	6.30	2.86

All dimensions, excluding weight, are maximum

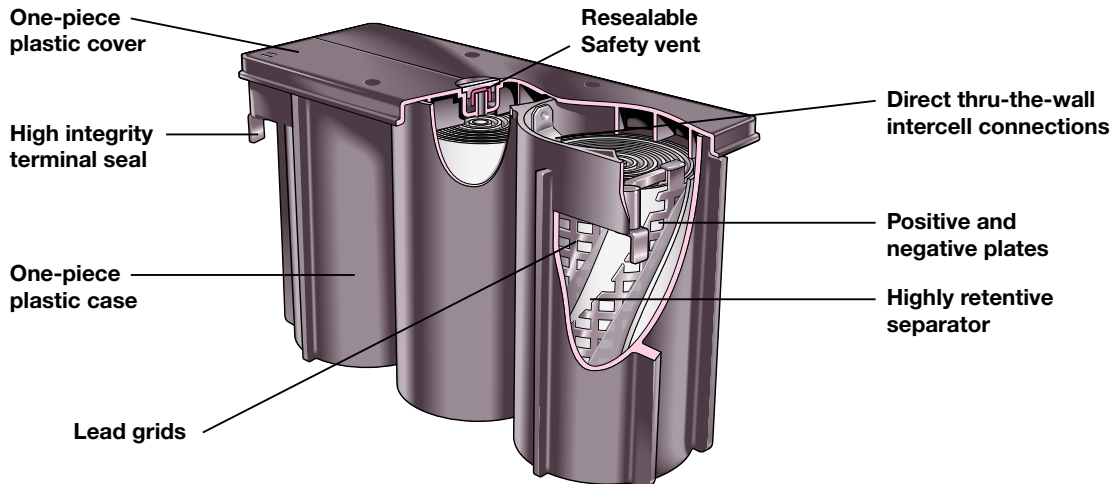

CYCLON® Battery 4V Monobloc mechanical specifications (A, B & C - maximum)

Products	DIMENSIONS													
	A		B		C		D		E		Weight		Tabs	
	in.	mm	in.	mm	in.	mm	in.	mm	in.	mm	lb.	kg	in.	mm
D Monobloc	2.75	69.9	3.13	79.5	1.81	46.0	.61	15.5	1.23	31.2	.80	.36	.187x.025	4.75x0.64
X Monobloc	3.02	76.7	3.80	96.5	2.12	53.8	.73	18.5	1.45	36.8	1.62	.74	.250x.025	6.35x0.64
E Monobloc	4.00	101.6	3.81	96.8	2.13	54.1	.73	18.5	1.45	36.8	2.11	.96	.250x.025	6.35x0.64

CYCLON® Battery 6V Monobloc mechanical specifications (A, B & C - maximum)

Products	DIMENSIONS																	
	A		B		C		D		E		F		G		Weight		Tabs	
	in.	mm	in.	mm	in.	mm	in.	mm	in.	mm	lb.	kg	in.	mm	lb.	kg	in.	mm
D Monobloc	2.75	69.9	4.48	113.8	1.81	46.0	.61	15.5	1.23	31.2	1.33	33.8	.67	17.0	1.15	.52	.187x.025	4.75x0.64
X Monobloc	3.02	76.7	5.48	139.2	2.12	53.8	.73	18.5	1.45	36.8	1.71	43.4	.86	21.8	2.12	.98	.250x.025	6.35x0.64
E Monobloc	4.00	101.6	5.48	139.2	2.13	54.1	.73	18.5	1.45	36.8	1.71	43.4	.86	21.8	3.15	1.43	.25x.025	6.35x0.64

D Monobloc

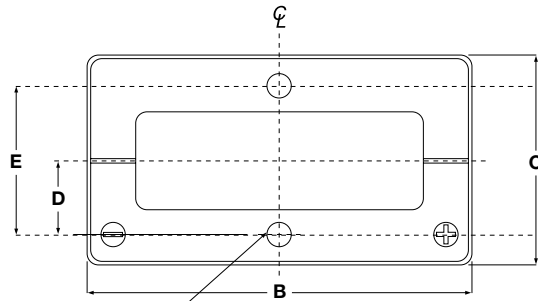
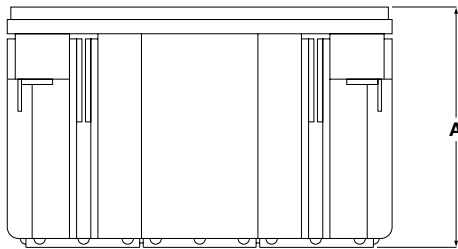

X & E Monobloc

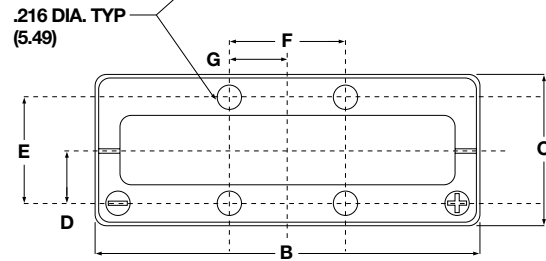
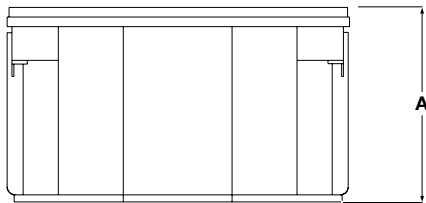

4V/6V Monobloc constant current (CC) curves to 1.67Vpc

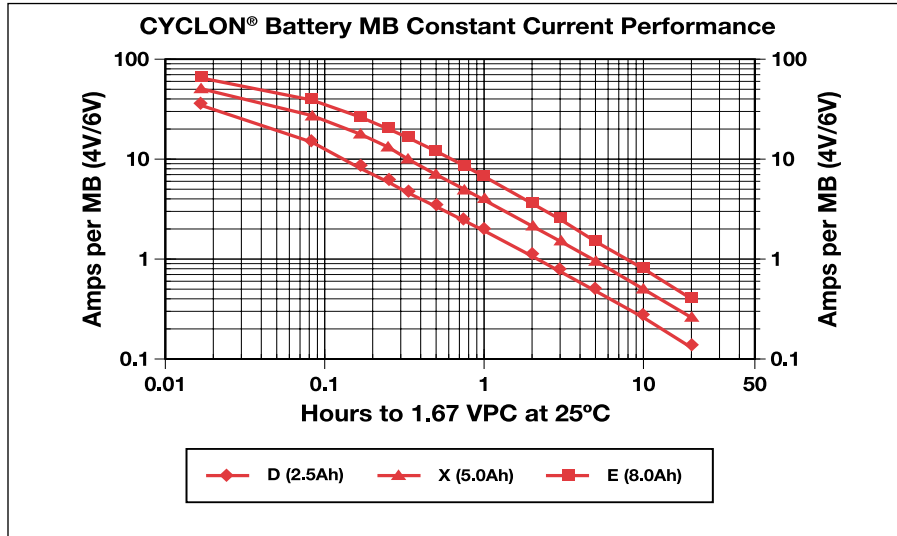

4V/6V Monobloc constant power (CP) curves to 1.67Vpc

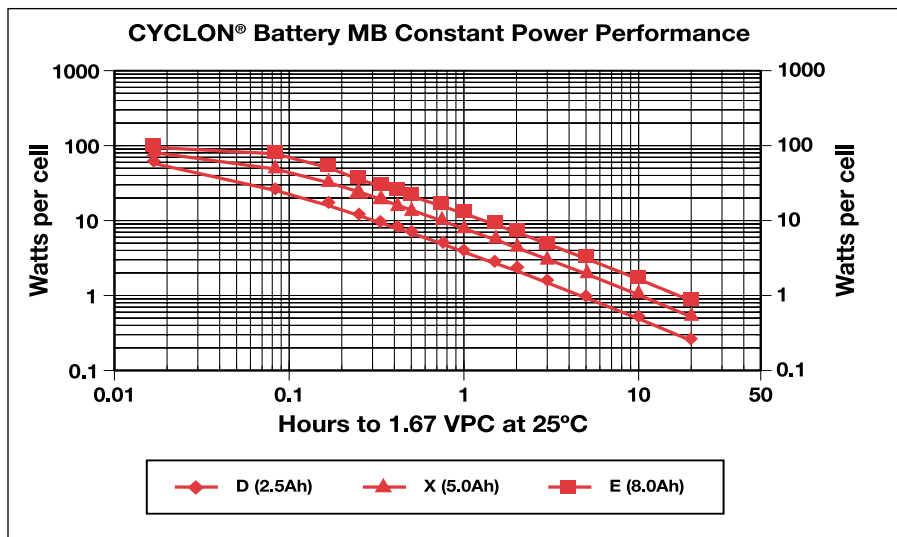

ENERSYS® STANDARD PRODUCT LIST

SINGLE CELL (sc)

PART NUMBER	DESCRIPTION	VOLTAGE	10 Hr RATE	PERFORMANCE SPECIFICATIONS	MECHANICAL SPECIFICATIONS
0810-0004	D Single Cell (Dsc)	2V	2.5Ah	Page 10	Page 13
0860-0004	DT Single Cell (DTsc)	2V	4.5Ah	Page 10	Page 13
0800-0004	X Single Cell (Xsc)	2V	5.0Ah	Page 10	Page 13
0850-0004	E Single Cell (Esc)	2V	8.0Ah	Page 10	Page 13
0840-0004	J Single Cell (Jsc)	2V	12.0Ah	Page 10	Page 13
0820-0004	BC Single Cell (BCsc)	2V	25.0Ah	Page 12	Page 13

SINGLE CELL STANDARD BATTERY DESIGNS

PART NUMBER	DESCRIPTION	VOLTAGE	10 Hr RATE	PERFORMANCE SPECIFICATIONS	MECHANICAL SPECIFICATIONS
0810-0102	1x3 Dsc, double slot, shrink wrap	6V	2.5Ah	Page 10	Page 11
0810-0103	1x3 Dsc, shrink wrap, leads	6V	2.5Ah	Page 10	Page 11
0810-0011	1x3 Dsc, double slot, ABS case	6V	2.5Ah	Page 10	Page 11
0810-0077	1x3 Dsc, single slot, ABS case, leads	6V	2.5Ah	Page 10	Page 11
0860-0102	1x3 DTsc, double slot, shrink wrap	6V	4.5Ah	Page 10	Page 11
0860-0103	1x3 DTsc, shrink wrap, leads	6V	4.5Ah	Page 10	Page 11
0800-0102	1x3 Xsc, double slot, shrink wrap	6V	5.0Ah	Page 10	Page 11
0800-0103	1x3 Xsc, shrink wrap, leads	6V	5.0Ah	Page 10	Page 11
0800-0011	1x3 Xsc, double slot, ABS case	6V	5.0Ah	Page 10	Page 11
0800-0071	1x3 Xsc, single slot, ABS case, leads	6V	5.0Ah	Page 10	Page 11
0850-0102	1x3 Esc, double slot, shrink wrap	6V	8.0Ah	Page 10	Page 11
0850-0103	1x3 Esc, shrink wrap, leads	6V	8.0Ah	Page 10	Page 11
0810-0108	1x6 Dsc, double slot, shrink wrap	12V	2.5Ah	Page 10	Page 11
0810-0109	1x6 Dsc, shrink wrap, leads	12V	2.5Ah	Page 10	Page 11
0810-0016	1x6 Dsc, double slot, ABS case	12V	2.5Ah	Page 10	Page 11
0810-0075	1x6 Dsc, single slot, ABS case, leads	12V	2.5Ah	Page 10	Page 11
0810-0114	2x3 Dsc, double slot, shrink wrap	12V	2.5Ah	Page 10	Page 11
0810-0115	2x3 Dsc, shrink wrap, leads	12V	2.5Ah	Page 10	Page 11
0810-0008	2x3 Dsc, double slot, ABS case	12V	2.5Ah	Page 10	Page 11
0810-0067*	2x3 Dsc, Styrene case, leads	12V	2.5Ah	Page 10	Page 11
0860-0108	1x6 DTsc, double slot, shrink wrap	12V	4.5Ah	Page 10	Page 11
0860-0109	1x6 DTsc, shrink wrap, leads	12V	4.5Ah	Page 10	Page 11
0860-0114	2x3 DTsc, double slot, shrink wrap	12V	4.5Ah	Page 10	Page 11
0860-0115	2x3 DTsc, shrink wrap, leads	12V	4.5Ah	Page 10	Page 11
0800-0108	1x6 Xsc, double slot, shrink wrap	12V	5.0Ah	Page 10	Page 11
0800-0109	1x6 Xsc, shrink wrap, leads	12V	5.0Ah	Page 10	Page 11
0800-0016	1x6 Xsc, double slot, ABS case	12V	5.0Ah	Page 10	Page 11
0800-0072	1x6 Xsc, single slot, ABS case, leads	12V	5.0Ah	Page 10	Page 11
0800-0114	2x3 Xsc, double slot, shrink wrap	12V	5.0Ah	Page 10	Page 11
0800-0115	2x3 Xsc, shrink wrap, leads	12V	5.0Ah	Page 10	Page 11

SINGLE CELL STANDARD BATTERY DESIGNS (continued)

PART NUMBER	DESCRIPTION	VOLTAGE	10 Hr RATE SPECIFICATIONS	PERFORMANCE SPECIFICATIONS	MECHANICAL
0800-0008	2x3 Xsc, double slot, ABS case	12V	5.0Ah	Page 10	Page 11
0800-0047*	2x3 Xsc, Styrene case, leads	12V	5.0Ah	Page 10	Page 11
0850-0108	1x6 Esc, double slot, shrink wrap	12V	8.0Ah	Page 10	Page 11
0850-0109	1x6 Esc, shrink wrap, leads	12V	8.0Ah	Page 10	Page 11
0850-0114	2x3 Esc, double slot, shrink wrap	12V	8.0Ah	Page 10	Page 11
0850-0115	2x3 Esc, shrink wrap, leads	12V	8.0Ah	Page 10	Page 11
0820-0030	2x3 BCsc, double slot, copper strap	12V	25.0Ah	Page 12	Page 12

MONOBLOC (mb)

PART NUMBER	DESCRIPTION	VOLTAGE	10 Hr RATE	PERFORMANCE SPECIFICATIONS	MECHANICAL SPECIFICATIONS
0819-0010	D Monobloc (Dmb)	4V	2.5Ah	Page 15	Page 17
0809-0010	X Monobloc (Xmb)	4V	5.0Ah	Page 15	Page 17
0859-0010	E Monobloc (Emb)	4V	8.0Ah	Page 15	Page 17
0819-0012	D Monobloc (Dmb)	6V	2.5Ah	Page 15	Page 17
0809-0012	X Monobloc (Xmb)	6V	5.0Ah	Page 15	Page 17
0859-0012	E Monobloc (Emb)	6V	8.0Ah	Page 15	Page 17

MONOBLOC STANDARD BATTERY DESIGNS

PART NUMBER	DESCRIPTION	VOLTAGE	10 Hr RATE	PERFORMANCE SPECIFICATIONS	MECHANICAL SPECIFICATIONS
0819-0016	1x6 Dmb	12V	2.5Ah	Page 15	Page 16
0819-0030	2x3 Dmb	12V	2.5Ah	Page 15	Page 16
0809-0016	1x6 Xmb	12V	5.0Ah	Page 15	Page 16
0809-0030	2x3 Xmb	12V	5.0Ah	Page 15	Page 16
0859-0016	1x6 Emb	12V	8.0Ah	Page 15	Page 16
0859-0030	2x3 Emb	12V	8.0Ah	Page 15	Page 16

CAPACITY RATINGS BASED ON END OF DISCHARGE VOLTAGE OF 1.67 VOLTS/CELL AT 25°C

*Due to special assembly, consult the EnerSys® Customer Service Department for availability.



Canada

+1 (888) 271-8888
sales@magnacharge.com

United States

+1 (844) 370-0258
sales@magnacharge.com

Panama

+011 (507) 209-4776
info@magnachargepa.com

www.MAGNACHARGE.com